

JAMES HETHERINGTON
ENGINEER
ALLOYD RESEARCH CORP.
802 ARSENAL ST.
WATERTOWN, MASS.

JAMES HETHERINGTON
ENGINEER
ALLOYD RESEARCH CORP.
802 ARSENAL ST.
WATERTOWN, MASS.

PROCEEDINGS OF FIRST
SYMPOSIUM ON ELECTRON-BEAM MELTING

March 20, 1959

Hotel Somerset, Boston, Massachusetts

Compiled by

James S. Hetherington

alloyd research corporation

WATERTOWN MASSACHUSETTS



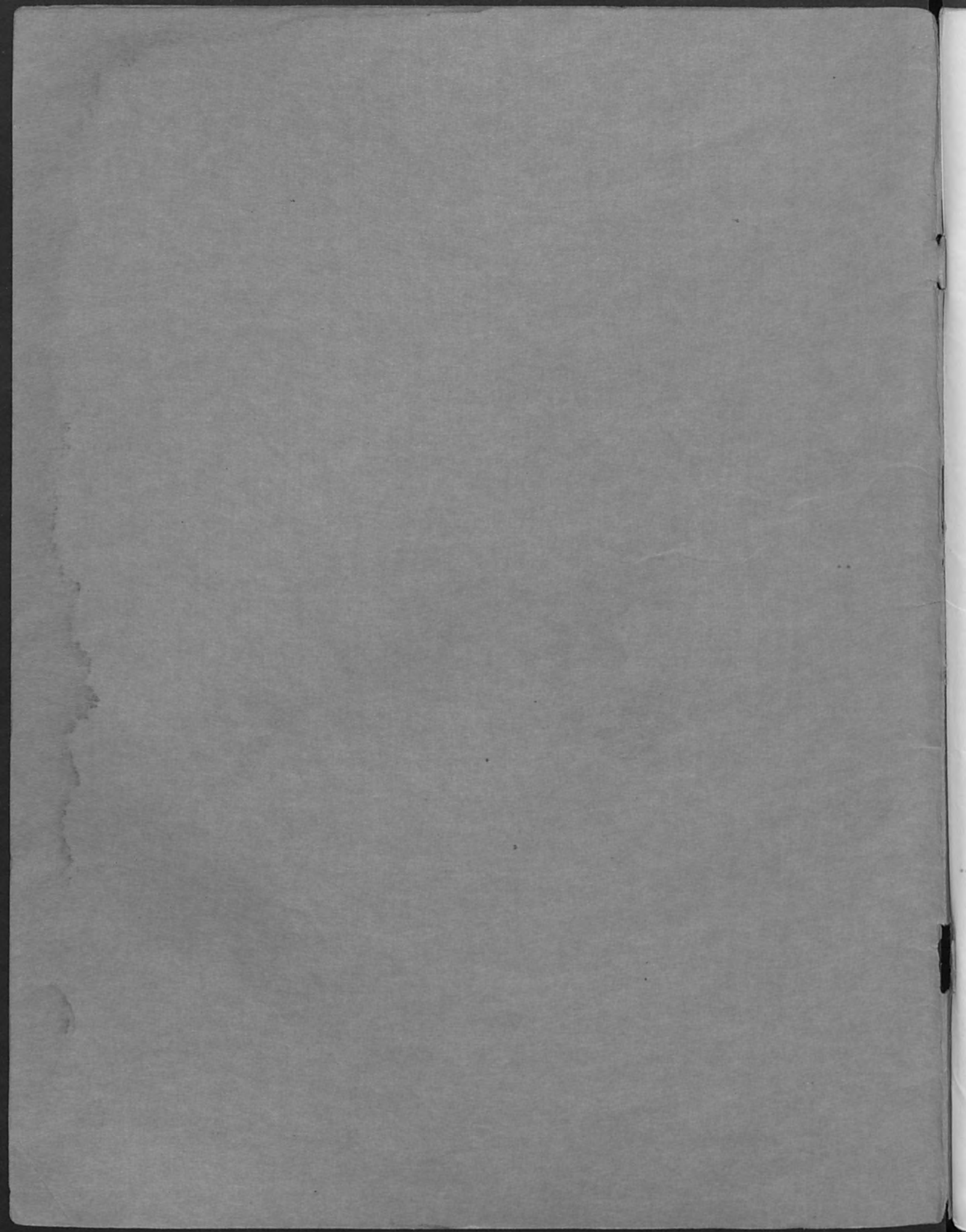

Bauer

PROCEEDINGS OF FIRST
SYMPOSIUM ON ELECTRON-BEAM MELTING

March 20, 1959

Hotel Somerset, Boston, Massachusetts

Compiled by

James S. Hetherington

Sponsored By

ALLOYD RESEARCH CORPORATION
202 Arsenal Street
Watertown 72, Massachusetts

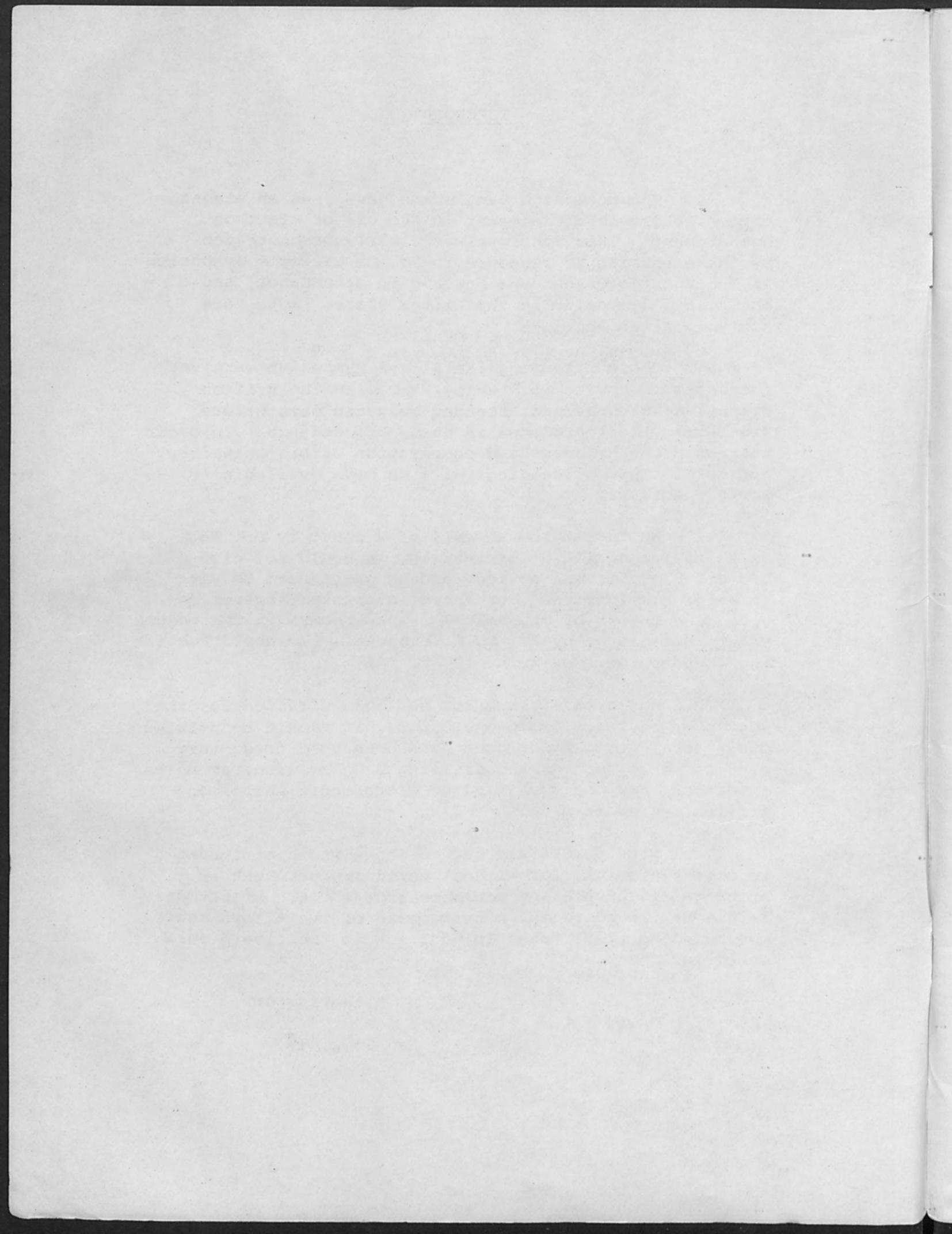

FOREWORD

The past eighteen months have seen an almost explosive growth of interest in the use of electron bombardment. This interest was clearly demonstrated by the enthusiastic response to Dr. Calverley's Symposium in England (more than one hundred in attendance) and to the Alloyd Symposium in the United States (more than sixty in attendance).

Those attending the Alloyd Symposium were very fortunate in having Dr. Lawley summarize the British Symposium which he had attended only ten days before. His summary is reproduced in these proceedings. In order to return the kindness and cooperation of Dr. Calverley, copies of these proceedings will be made available to workers abroad.

We regret the absence of a paper by Dr. Hugh Smith of Temescal. Unfortunately, we could not give Dr. Smith sufficient notice, and he was forced to yield to prior commitments. For those interested; however, a very fine report of Dr. Smith's work appears in the volume Vacuum Metallurgy by Dr. R. F. Bunshah. (Reinhold Publishing Corporation, New York, 1958).

While this symposium has been directed for the most part at large scale operations, it should be pointed out that electron bombardment has been used to do very precise work, such as the drilling 0.01 mm diameter holes in diamond and the machining of microscopic shapes on difficult-to-work metals.

Many thanks are due to those who contributed to this symposium, for without their support such an exchange of information would be impossible. Gratitude is also extended to the many members of the Alloyd staff who accepted these tasks in addition to their very full schedules.

J. Hetherington

May 20, 1959

The past six months have seen an almost explosive growth of interest in the use of electronic computers. This interest was largely stimulated by the emphasis on computers in the National Defense Education Act (NDEA) and the National Science Foundation (NSF) in 1958. The NDEA provides for the training of personnel in the use of computers in the field of education, and the NSF provides for the training of personnel in the use of computers in the field of science.

Those attending the Allied Hypnosis Workshop in New York City, New York, on May 15-16, 1958, were very fortunate in having Dr. Lawrence S. Schwartz, the author of the book "Hypnosis: A Practical Approach" (New York: Holt, Rinehart & Winston, 1957), in order to present his paper on "Hypnosis and the Computer". His summary is reproduced in these proceedings. In order to receive the kindness and cooperation of Dr. Schwartz, copies of these proceedings will be made available to his office.

We regret the absence of a paper by Dr. Schwartz on "Hypnosis and the Computer". Unfortunately, we could not give Dr. Schwartz sufficient notice, and he was forced to yield to prior commitments. For those interested, however, a very fine report of Dr. Schwartz's work appears in the volume "Hypnosis and the Computer" (New York: Holt, Rinehart & Winston, 1958).

While this symposium has been directed for the most part at large scale questions, it should be pointed out that smaller scale questions have also been used to do very precise work, such as the drilling of diamond holes in diamonds and the production of electronic tubes on a microscopic scale.

Many thanks are due to those who contributed to this symposium for their kind support and an exchange of information with the organizers. Dr. Schwartz is also thanked for the very kind support of the Allied Hypnosis Workshop and the National Science Foundation. It is hoped that these tasks in addition to their very full schedules.

J. H. H. H.

May 20, 1958

ELECTRON-BEAM MELTING SYMPOSIUM

TABLE OF CONTENTS

	<u>Page No.</u>
SYMPOSIUM ON ELECTRON BOMBARDMENT FLOATING ZONE MELTING AND ALLIED TECHNIQUES. A. Lawley, University of Pennsylvania	1
AN ELECTRON BEAM APPARATUS FOR PURIFICATION OF BERYLLIUM. J. Hetherington, Alloy Research Corporation	18
APPARATUS FOR ZONE-LEVELLING W-Ta AND W-Nb ALLOYS. D. Ferriss, Mass. Institute of Technology	23
A.V.S. STANDARDS FOR VACUUM EQUIPMENT. W. G. Matheson, American Vacuum Society	25
AN ELECTRON BOMBARDMENT FURNACE FOR THE PRODUCTION OF VACUUM- MELTED METALS. E. Candidus, National Research Equipment Corporation	27
E-B MELTING OF Ti AND Ti ALLOYS. S. Abkowitz, Mallory-Sharon Corporation	34
ELECTRON-BEAM FLOATING-ZONE MELTING OF PLATINUM-GROUP METALS. W.P. Allred, R.C. Himes, H.L. Goering, Battelle Memorial Institute	38
ELECTRON BOMBARDMENT APPARATUS FOR ZONE-MELTING OF TUNGSTEN. J.L. Orehotsky, A.J. Opinsky, Sylvania Research Laboratories	44
A LABORATORY PROTOTYPE ELECTRON- BEAM WELDER. A. Lesnewich, Air Reduction Company	48

TABLE OF CONTENTS, CONT.

	<u>Page No.</u>
ELECTRON BOMBARDMENT MELTING OF TUNGSTEN. H.W. Schadler, General Electric Company	51
PRODUCTION OF RODS FROM FINELY DIVIDED SILICON ²⁸ ISOTOPE BY ELECTRON-BEAM MELTING. E. Buehler, Bell Telephone Laboratories	58
CONVERSION OF A CONSUMABLE ARC- MELTING FURNACE TO ELECTRON-BEAM MELTING OF TITANIUM. L. L. France, Westinghouse Electric Corporation	62
THE ZONE-MELTING OF TUNGSTEN BY ELECTRON BOMBARDMENT. W.R. Witzke, National Aeronautics and Space Administration	73
AN ATTEMPT TO ZONE-MELT SAPPHIRE BY E-B TECHNIQUES. A. R. Strnad, Bell Telephone Laboratories	82
A COMMERCIAL ELECTRON-BEAM WELDER. T. H. Crane, High Vacuum Equipment Corporation	84
ON THE PURIFICATION OF TUNGSTEN BY ELECTRON-BEAM REFINING. J. W. Pugh, General Electric Company	89

SYMPOSIUM ON ELECTRON BOMBARDMENT FLOATING ZONE

MELTING AND ALLIED ELECTRON BOMBARDMENT TECHNIQUES

Held at S.E.R.L. Laboratories, Baldock, Herts, England
Alan Lawley, University of Pennsylvania

I. Applications of electron bombardment at
S.E.R.L., Baldock, Herts, England. A. Calverley.

A description of an improved form of beam melting unit was given (S.E.R.L. Technical Journal Vol. 8, No. 4, September 1958). The chamber is pumped via 5" diameter stainless trunking with a pumping speed of 150 litres/sec. The cathode assembly is mounted on an insulated demountable bridge which is moved up and down by a rotating lead screw. Additional features include axial adjustment of both chucks with fine control over the bottom chuck to allow for rapid closing or joining up if necking or breakage occurs. Rods of from 1/16" to 1/2" diameter may be accommodated. A traversal length of 22 cm. with variable traverse speeds from 0 to 350 cm/hour is used. An initial vacuum of 10^{-6} mm Hg is attained which rises to not more than 10^{-5} mm Hg during operation.

A summary of the elements and alloys zone melted is given;

Molybdenum

Specimens of 1/4" diameter rod having had 9 zone refining passes were sent to Dr. Wulff at M.I.T. Tests on specimens swaged from this material gave transgranular fractures down to -196°C . Efforts to determine residual oxygen, nitrogen, carbon by vacuum fusion failed. Tungsten pick up occurred in the zone-refined material.
(A.S.M. Handbook: The Metal Molybdenum Ch. 13).

Nickel

Nickel has been successfully beam melted. Formation of single crystals during zoning did not always occur.

Cobalt

No success with cobalt as yet. The cobalt formed a low melting point alloy with the tungsten filament. The need for a screened cathode is indicated here.

Copper

Has a low surface tension and there is much heat loss by conduction.

Vanadium, Niobium, Tantalum

These metals were successfully zone refined to give V.D.H. figures of 80, 51, 76, for Vanadium, Niobium, Tantalum, respectively. In the case of Vanadium, a 30 per cent loss by evaporation occurred. A rod of Tantalum of .060 inch diameter was zone melted. This is the smallest diameter attempted, as yet.

Alloys: Ta-Nb

Zone melted at 100 cm/hour to avoid segregation. Single crystals were produced with no apparent variation in density. Ta and Nb form B.C.C. solid solutions. For the 50-50 alloy, the V.D.H. was in the range 75 to 95.

Ta-V

Due to evaporation of the Vanadium, Tantalum rich specimens were always produced.

Boron

Specimens for zone melting were prepared by powder compacting. The material has a high thermal resistance. Despite slow heating and traversing, the specimen breaks up in the chamber. Not successfully treated as yet.

Insulators: Alumina, Sapphire, Ruby

With these insulators, the cathode becomes coated. There is much loss of heat by radiation, due to the transparency of the sample.

The Weight Drop Method for Determining Surface Tension

The dimensions of a molten bead of metal are taken at a temperature assumed to be at, or very near, the melting point. The weight of the fallen drop is then taken. Results are 2300 and 2020 dynes per cm. for Tungsten and Tantalum respectively.

II Zone Melting of Molybdenum, J.A. Belk Armament Research and Development Establishment, Kent, England.

The beam melting unit is housed in a water cooled steel chamber, the latter having a central viewing port. The cathode remains stationary, and the specimen, and specimen holder frame moved downwards relative to the cathode. An initial vacuum of 10^{-5} mm. Hg is attained using a mercury diffusion pump with a liquid nitrogen trap. Much build up of molybdenum occurs on the tungsten filament causing a change in bombardment conditions. Belk finds that by using a flat rolled tungsten loop, there is much less build up, and the loop is less prone to sagging. (The .028 inch diameter Tungsten wire is rolled flat at 900 C.). With 1/4 inch diameter rod, there is a 13 per cent loss of molybdenum per pass. Tungsten pick up (.05%) is observed after four passes at a zoning speed of 3 mm. per minute.

Refining of Molybdenum

After one pass the distribution of carbon along the rod was as is shown in Figure 1.

Figure 1.

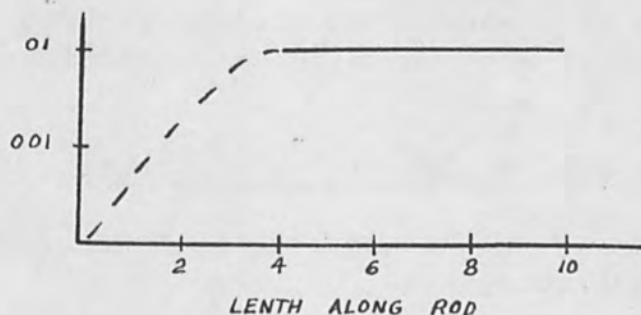

Lower limit of method of analysis is 7p.p.m.

Much of the carbon removed is believed to evolve as CO ie: the purifying action is chemical rather than a zone refining action.

Figure 2. Impact Tests:

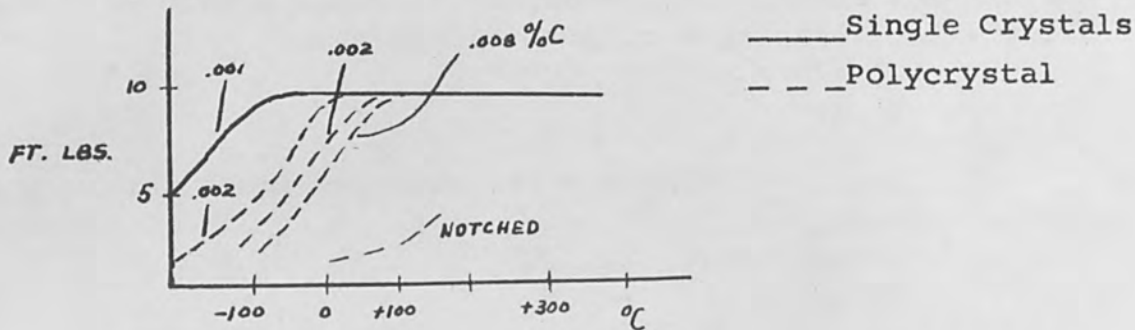

Alloys: Mo-W

These alloys are produced either by powder compacting or by wrapping Tungsten wire around a molybdenum rod and then melting the whole assembly followed by reversal, and re-melting, etc.

Electron Beam Melting

The method requires roughly 25 per cent more power than for refining. It is essential to outgas the rod originally.

III The Electron Bombardment Melting of Compounds and Alloys: F.O. Jones, A.E.I. Ltd, Aldermaston Court, Aldermaston, Berkshire, England.

The A.E.I. Group used the moving specimen technique the specimen being held in a water cooled frame. The whole assembly is housed in a water cooled brass jacket. A current limiting controller is used which is described in the J. Sci. Instruments. Vol. 36, 66, 1959.

Alloys: U-Zr, Mo-Re, TiC, WC, W₂C, TaC.

Use 2kv at a working pressure of 10^{-4} mm. Hg for the binary metallic systems.

Mo-Re:

The original material was arc-cast. Zoning at 2 m.m. per minute gave single crystals. Since no σ phase was detected, it was concluded that there was little loss of molybdenum during zoning. It appears therefore, that the Rhenium considerably reduces the vapor pressure of the alloy relative to that of pure molybdenum.

U-Zr:

Zoning of the original arc-cast ingot gave polycrystalline rod.

Ti-C:

Initial rod specimens prepared by hydrostatic compression. A glow discharge occurs at temperatures 2000°C due to the high vapour pressure of Titanium.

WC:

Volatilisation of carbon occurs; zone melting occurs relatively easily.

W₂C:

After zoning, the surface is found to be tungsten rich. The specimen is a mixture of W + W₂C.

TaC:

Zone melting resulted in a surface layer of TaC; Ta₂C; Ta 1/32 inch thick. The shape of the molten zone (tear drop profile) indicated a low surface tension.

Zirconium Oxide; (ZrO₂)

Very low surface tension as indicated by the shape of the molten zone.

IV Preliminary Experiments on Electron Bombardment
Floating-Zone Melting of Platinum Metals, D.W. Rhys:
The Mond Nickel Co., Bashley Rd., London N.W. 10

The metals zone melted include Pt, Rh, Ru, Ir, Os.
A working voltage 300 volts was used.

Pt:

The charge was air melted, cast, and then swaged into 2 inch diameter rod. Gas evolution was not observed, a stable zone resulting on the first pass.

Rh:

Much gas evolution. Specimens required many passes before stable zones were possible.

Ru:

Hydrostatically compressed powder was sintered at 1500°C at 10^{-4} mm. Hg. The rod specimens evolved very little gas on the first pass.

Ir:

As in the case of ruthenium, a little gas evolution occurred during the first pass.

V Production of Pure Materials by Electron Bombardment Including Single Crystals of Mo-Re.
A Lawley, R. Maddin, School of Metallurgical Engineering, Univeristy of Pennsylvania, Philadelphia 4, Pennsylvania, U.S.A.

The work on Mo-Re alloys is part of a program on body centered cubic structures, sponsored by the American Office of Naval Research. Geach and Hughes (1) and Duke (2), and Sims et al (3) have shown that at approximately 35 at. per cent (50 weight per cent) Re in molybdenum, a marked increase in ductility occurred, the lattice structure still being body centered. The above work indicated that coarse twinning followed by slip was the primary mode of deformation. In the present work, it is intended to study systematically the deformation characteristics of single crystals of various Mo-Re alloys. Further, thin film work with the electron microscope on Mo-Re is planned.

After failure to grow single crystals of the alloy by strain anneal methods, it was decided to try the floating zone, electron bombardment technique.

The unit consists of a 1/2 inch diameter ring cathode made from .015 inch diameter tungsten wire which moves concentrically down the length of the specimen, the latter remaining stationary. The rod specimen is held vertically in a stainless steel frame and is spring loaded against the grips at each end by molybdenum springs. A thick, hollow molybdenum cylinder with a tantalum liner surrounds the cathode, while tantalum reflector plates are spaced at 1/8 inch above and below the plane of the cathode. The cathode is earthed and the specimen held at a high positive potential.

Movement of the cathode assembly is accomplished through a 1/2 inch diameter stainless steel lead screw working through a rotary vacuum seal in the base of the chamber. A variable speed D.C. motor gives traversal rates of from 0 to 5 mm. per minute, with a total traversal length of about 7-1/2 inches.

The whole assembly is housed inside a 12 inch diameter x 12 inch high pyrex bell jar, the latter resting on a 1/2 inch thick copper base plate. A four inch diameter pumping line with no right angle bends is used, the oil diffusion pump speed being about 200 litres per second. With a straight through type liquid nitrogen trap, an initial pressure of 3×10^{-6} mm. Hg is rapidly attained. During operation, the pressure rises to 10^{-5} mm. Hg.

Tantalum rod (0.125 inch diameter) has been successfully zone melted using a bombardment current of 125 mA at 2600 volts. Initial outgassing runs at temperatures on or just below the melting point were necessary. Similar considerations apply to .150 inch diameter molybdenum rod.

Attempts to run a stable molten zone down .085 inch diameter Mo-35 at .per cent Re rod proved unsuccessful. Presumably the diameter was below that necessary for the formation of a stable molten zone.

As yet, the effect of zone melting on the relative distribution of Mo and Re is not known. The partition coefficient K , as deduced from the equilibrium diagram of Dickinson and Richardson ⁽⁴⁾ is about .85 - .90 so that gross segregation of the alloy constituents would not be expected

Photographs of the equipment are given as plates I and II.

REFERENCES:

- (1) G.A. Geach and J. Hughes: Plansee Proc. 1955
- (2) C. Sims and R.I. Jaffee: Battelle Mem. Inst. April 1958
- (3) J.F. Duke, S.E.R.L. Report, August 1956.
- (4) J.M. Dickinson and L.S. Richardson, T.A.S.M. 51 1958

VI Electron Beam Floating Zone Melting of Platinum Group Metals: W.P. Allred, R.C. Hines, H.L. Goering, Battelle Memorial Institute, Columbus, Ohio, U.S.A.

A split tungsten tape filament was used;

Figure 3

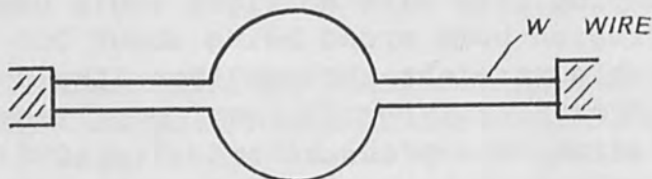

Platinum and Rhodium rods zone melted with a traverse speed of 6 cm. per hour. Under these conditions, no impurity segregation occurred but calcium and copper were lost by evaporation. Traversal speeds of less than 1-1 1/2 inch per hour were found to be necessary for impurity segregation. As an example of the purification of ruthenium, the oxygen content was reduced below 7p.p.m. and hydrogen and nitrogen contents to values below those amenable to quantitative analysis. ie: for hydrogen less than 0.2p.p.m.; for nitrogen less than 3p.p.m. The concentrations of Pa, Rh, Fe, Si, Cu, Pb, Sn, Mg were reduced at the "head" of the ingot, but iridium appears to concentrate in this section. ie; the distribution coefficient is greater than unity.

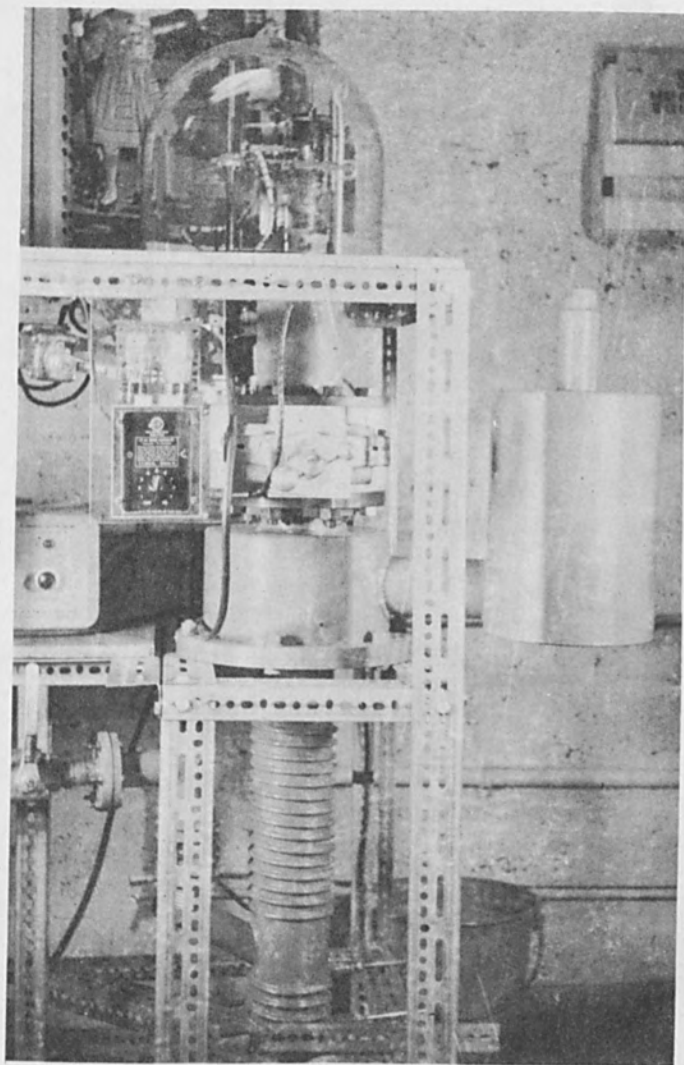

Plate I. Dr. Lawley's Apparatus
University of Pennsylvania

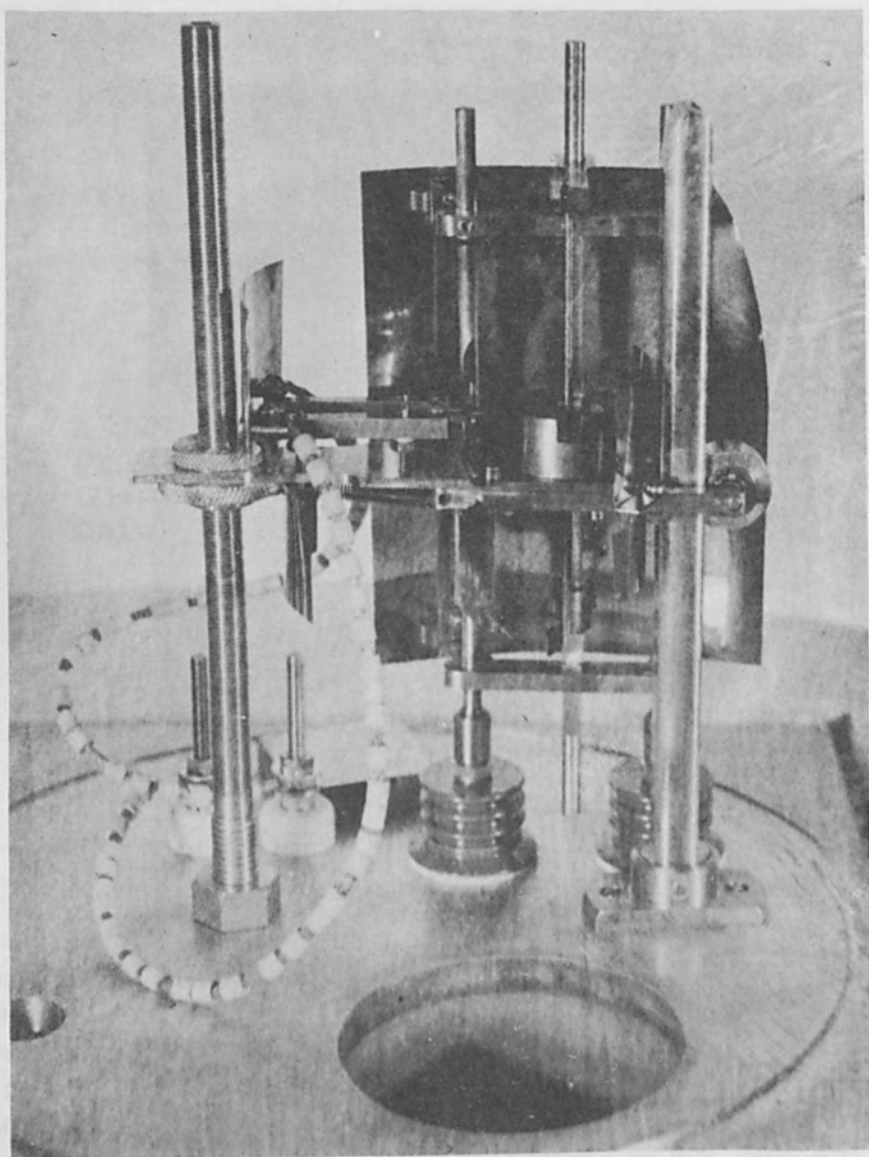
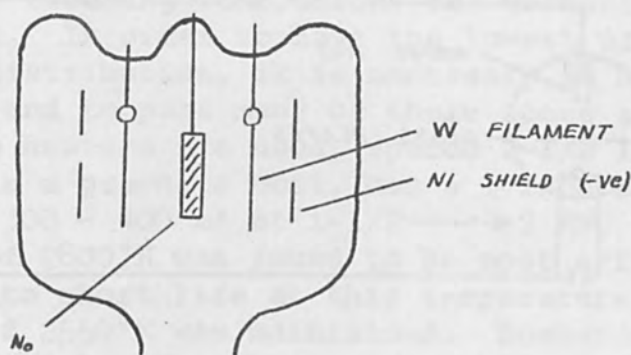

Plate II. Dr. Lawleys Apparatus
University of Pennsylvania

VII

Solid State Purification Using Electron Bombardment Heating At Pressures Less Than 10^{-7} mm. Hg., G.W. Warren, G.E.C., Ltd., Wembley, Middx., England

Figure 4



Electron bombardment was used as a means to ensure a vacuum of 10^{-7} mm. Hg. and therefore low surface concentration of gas, during outgassing of small molybdenum specimens. Mono layers of oxide form at 10^{-5} or 10^{-6} mm. Hg. Electron bombardment at 2000°C (50 watts/sq. cm.) gives 3p.p.m. of oxygen after prolonged treatment. By sealing the system off and using a Ba getter, with the nickel shield at a negative potential, the system acted as its own pump. At 2000°C , the logarithm of the residual gas content was a linear function of time, and in specimens 0.5 mm. diameter by 4 cm. long, and oxygen content of about 1p.p.m. was reached in eight hours. (Figure 5)

Figure 5

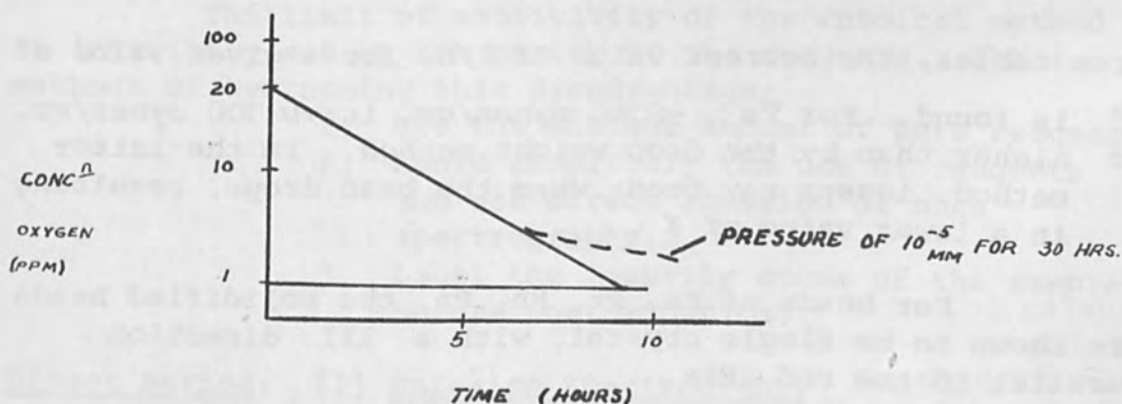

VIII An Electron Bombardment Vacuum Evaporation Apparatus, J.C. Kelly, Metallurgy Division, A.E.R.E. Harwell Berks, England

Figure 6

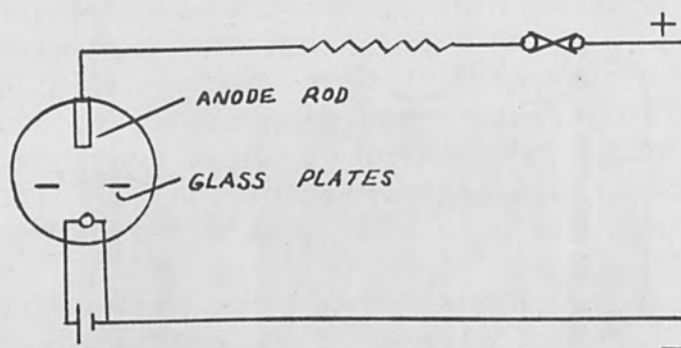

Films of Ta and Zr produced. Surface tension measurements were made on molten drops of material. The molten drop is photographed and d_s and d_e measured;

Figure 7

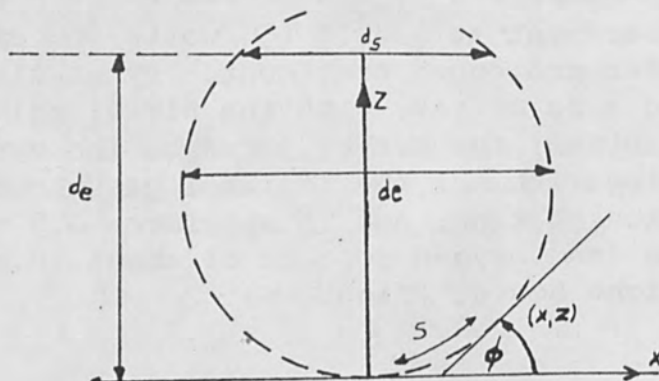

From tables, the correct value of $1/H$, for a given value of $\frac{d_s}{d_e}$ is found. For Ta -2360 dynes/cm. ie; ~ 300 dynes/cm. higher than by the drop weight method. In the latter method, losses may occur when the bead drops, resulting in a lower value of γ .

For beads of Fe, Pt, Rh, Pa, the solidified beads are shown to be single crystal, with a 111 direction parallel to the rod axis.

IX Zone Melting of Germanium By Electron Bombardment, P. Le. Couteur, G.E.C. Ltd., Wembley, Middx. England.

Le Couteur uses electron bombardment heating but does not have floating zone, since the germanium is in a graphite boat. In order to have the lowest ultimate limit of impurity distribution, it is necessary to maintain narrow zones and to pass many of these zones along the ingot. Seven heaters are used, spaced 2-1/2 inches apart. The sample, in a graphite boat, has a 1 inch square section and requires 300 - 400 mA at 1-1/2 → 2 KV. A cathode temperature of 2800°K was found to be most efficient; however, due to short life at this temperature, a cathode temperature of 2550°K was maintained. Bombardment current is maintained constant within ± 2 per cent by a simple saturated core type controller, Normally the ultimate distribution is influenced by the rate of contamination from gas but, using electron beam heating, lower ultimate distributions are easily attained. No actual impurity figures were given.

X A Review of Methods For Analyzing Zone Refined Metals, C.A. Parker, Admiralty Materials Lab. Poole, Dorset, England

Three main methods of analysis;

1. Chemical
2. Direct
3. Radiographic

The limit of sensitivity of the chemical method is invariably set by the purity of the reagents. Three methods of overcoming this disadvantage;

1. Use the minimum amount of pure reagent
2. Avoid completely the use of reagents and use direct emission of mass spectrography.
3. Label the impurity atoms of the sample before contamination.

Direct Method: (1) Emission Spectrography

1. The sample must be in a compact form in order to use as an electrode. Thus, powders are of no use.

2. The light emitted by the impurity is very small so that the method is not too sensitive.
3. Calibration against standard samples is necessary.

B in Si determined down to 0.1p.p.m. by this method

(2) Mass Spectrography

Again need electrodes of the material. Positive ions passed through magnetic and electrostatic fields and focussed onto photographic plate.

Detection of Bi, Pb, W down to 0.01p.p.m.

Radiographic Methods:

Thermal neutrons may be used to label the impurity atoms. eg; As in silicon;

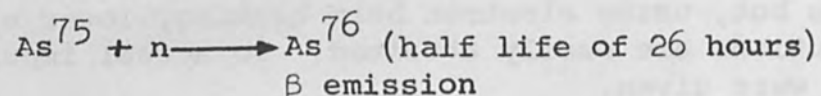

The magnitude of the β emission is noted, and the allowance made for other active components. Very easy to have just surface contamination. In a determination of the arsenic content in broad beams, the beams were irradiated with neutrons while still inside their pods. A value of 0.35p.p.m. was recorded.

The sensitivity of this method varies with the particular impurity. For the impurities in gold, the following limits of sensitivity are found;

down to:

10^{-11}	gm. In, Mn, Re
10^{-10}	gm. As, W, Cu
10^{-8}	gm. Mo, Ni, Si,
10^{-7}	gm Bi, Se, Ca, Cr, Fe
10^{-6}	gm S, Pb
7×10^{-6}	gm. C, N, O

Proton Excitation;

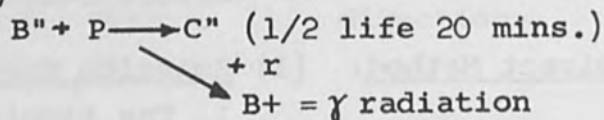

XI The Construction Of A Crystal Pulling Furnace
Using Electron Bombardment Heating, D.B. Gasson,
A.E.I. Ltd., Aldermaston, Berks, England.

Silicon grown in a crucible has an oxygen content in excess of 10^{18} atoms per c.c. By using the electron beam technique, a value less than 10^{17} atoms per c.c. is found.

Figure 8

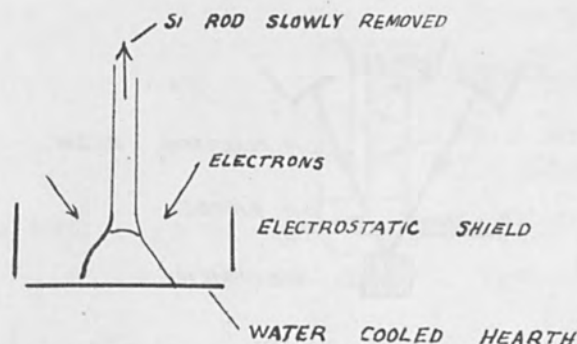

Four guns placed 90° apart axially to the silicon rod, are focused to give a molten pool of material at the base of the rod. The guns are kept well away from the charge in order to facilitate viewing and also to avoid contamination. The whole unit is placed inside a glass cylinder. There is independent power control to each $1\text{-}1/4$ K.W. gun. The tungsten filaments may be re-focused during growth of the crystal.

Figure 9

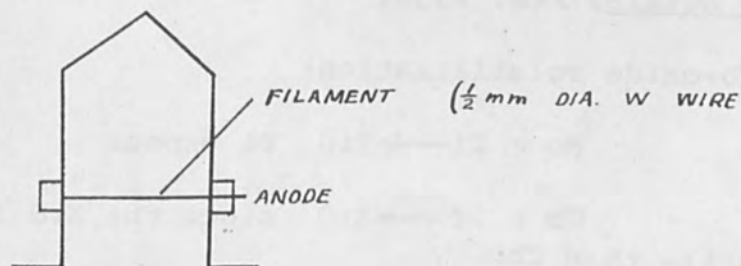

Power from a three phase rectified supply up to 5 K.V.

XII

Electron Beam Welding, J. A. Stohr and Mr. Thome,
Centre d'Etudes Nucleaires de Saclay, Gif-Sur-
Yvette, France.

Welding areas as low as 1 sq. cm. may be obtained in thin metal sheet. A very high current density is produced;

Figure 10

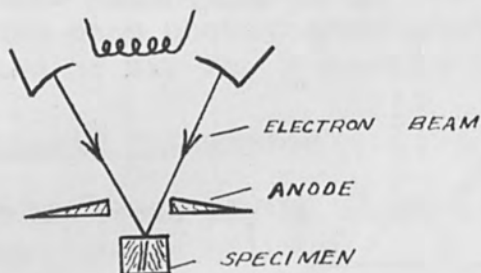

Construction of elaborate types of gun are in progress. The method is used for welding fuel elements on a commercial scale.

Discussion;

Powell: Johnson Matthey Co., Ltd., London

Discussion of the possibility of purification of Mo by the addition of Yttrium. Mo does not alloy with rare earths. ie; Mo (Ta impurity 2 per cent Yttrium) VDH reduced from 500 to 120. of paper by Smith, da'Hunt, Hanks, J. Metals, Feb. 1959.

Use of Sub-oxide volatilization:

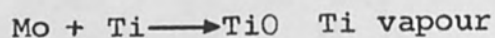

$\text{Cb} + \text{Zr} \longrightarrow \text{ZrO}$ since the ZrO is ten times more volatile than CbO

W + Ti or Zr to remove oxygen.

Holland: Edward's High Vacuum, Crawley, Sussex., England.
Technique for Evaporation of Aluminum.

Because of the oxide skin, aluminum normally has to be heated to 1100C for evaporation. In order to do this, the aluminum is fed down a capillary in a refractory tube.

Figure 11

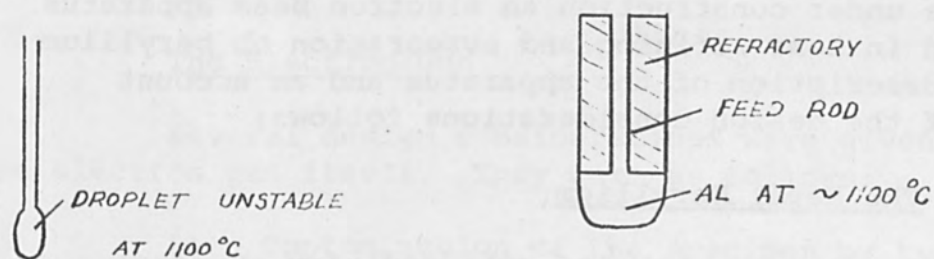

Evaporation rate of 1 gm/minute for titanium.

AN ELECTRON BEAM APPARATUS FOR
PURIFICATION OF BERYLLIUM

by

J. Hetherington
Alloyd Research Corporation

As one facet of a program aimed at obtaining samples of ultra-pure beryllium, Alloyd Research Corporation has under construction an electron beam apparatus to be used in zone refining and evaporation of beryllium rods. A description of the apparatus and an account of some of the design considerations follows;

The Metal Beryllium

Beryllium, with its extraordinary physical and density properties has proven to be of great interest for use as a structural material in devices where strength-to-weight ratios are important. Efforts aimed at removing the brittle behavior of this metal have been substantial. In support of these efforts it is necessary that small quantities of ultra-pure beryllium be available. Methods which are being applied towards such purification include the use of electron bombardment in high vacuum. Because beryllium is so reactive and has a high vapor pressure at temperature near its melting point, it has been necessary to design special features into the bombardment and vacuum system.

The Power Supplies

The main source of power is a high voltage DC source, adjustable from 0-20,000 volts, up to 1/2 ampere (10,000 watts). This voltage is higher than most workers use, but was chosen because the beryllium anode is likely to be covered with beryllium oxide, which is an excellent secondary emitter. Secondary emission ratios greater than unity and accompanying space charge are normally encountered from a nominal 50 volts to 15,000 volts. In specifying the voltage, therefore, it was decided that a potential in excess of 15,000 volts might be desirable. On the other hand, operation at a lower voltage might necessitate 500 ma of current, so the supply was thus designed.

A filament transformer with secondary rated at 50 volts, 50 amperes, center tapped and isolated for 25,000 volts is used.

Two identical supplies are incorporated for accelerator and repeller potentials. These are adjustable from 0 to 7.5 KV at 50 ma.

An alternate to the main power supply is on hand, a surplus RA38 radar supply 0-15,000 volts DC at 500 ma. Changeover to this supply can be made in a matter of minutes.

The Electron Gun

Several design considerations were given to the electron gun itself. They were as follows:

(1) Contamination of the specimen by tungsten. Two attempts to minimize this distinct possibility are made by designing a filament that operates at a minimum temperature, and designing electrodes in the gun so that only a small angle is subtended from the filament to the work.

(2) Arcing. Electrodes are positioned so that the electron beam from the filament flows through a cylindrical aperture that is at essentially the same potential as the bombarded rod. Thus ions formed at the rod will "see" no field gradient and the tendency to arc be diminished. If the aperture can be made small enough, outgassing of the specimen will not tend to increase the pressure in the gun, and will be gettered by beryllium condensed on the aperture plates.

(3) Ruggedness and Flexibility. Previous experience has indicated that frequent changes of filaments, electrode configurations and insulators are necessary. This electron gun was designed so that assembly and dis-assembly is fast and convenient. Entire structures can be changed to try new electrode configurations. Figure 1 shows the electron gun and Figure 2 the vacuum system and control panel. The power supplies are remotely controlled.

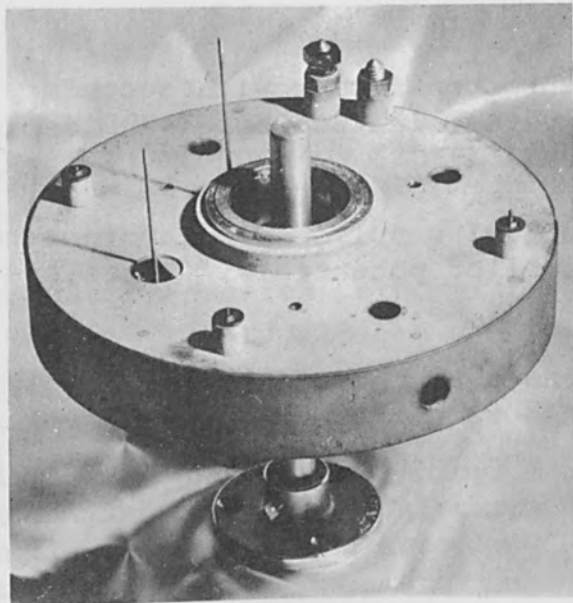

Figure 1
Electron Gun

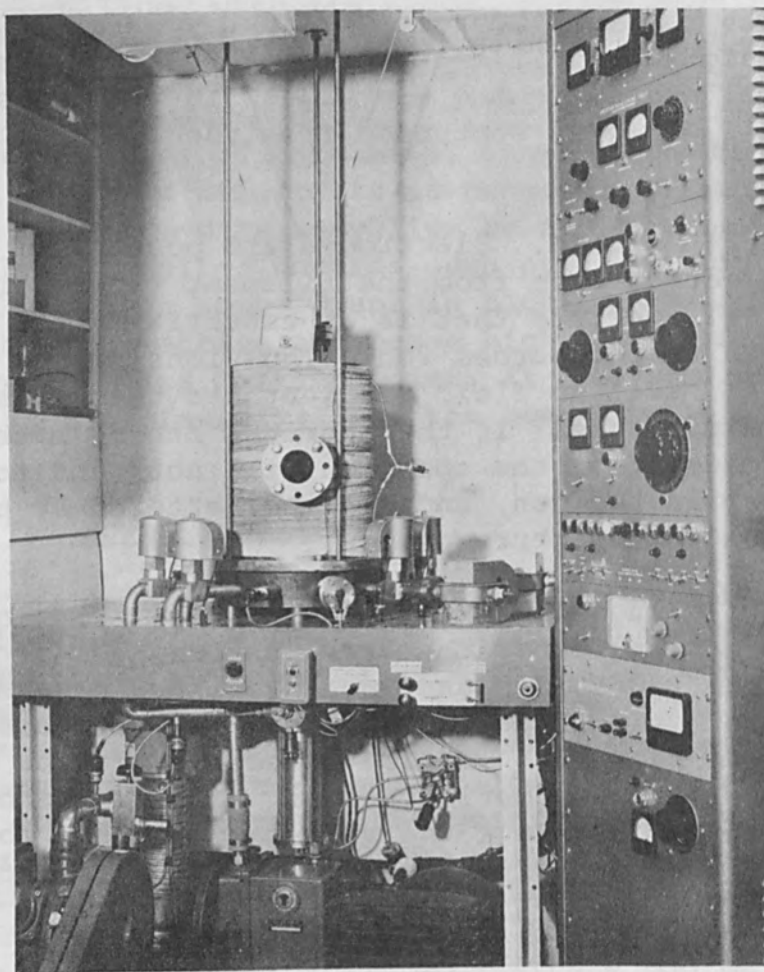

Figure 2
Vacuum System and Control Panel

The Vacuum System

The vacuum chamber is a stainless steel bell jar 12 inches in diameter, 18 inches high, with viewing ports. The base has a number of radial tubes welded in to accept gauges, electrical feed thrus, Vac-Ion pumps and other devices as desired. The system is pumped down to the 10^{-6} mm Hg. range by a conventional oil diffusion pump and freon baffle, at which point that system is valved off by electro-pneumatic valves, and pumping is taken over by two Vac-Ion pumps. These pumps have attained a vacuum of 10^{-9} mm Hg. in this system under static conditions, after baking out the chamber. The Vac-Ion pumps have a comparatively low pumping speed for electron-beam melting, so they are used to attain high initial vacuums after outgassing. In addition beryllium evaporating from the melt should have a gettering action, which will improve the vacuum. The vacuum is metered by the usual thermocouple and cold discharge gauge down to 10^{-6} mm Hg. and by a modified Bayard-Alpert gauge down to 10^{-11} mm Hg. A contact making meter on the discharge gauge can be set to actuate the solenoid valves automatically to bring in the diffusion pump and close off the Vac-Ion pumps when the pressure goes over a present limit.

Results

The electron gun, power supply and vacuum system have all been tried on test materials such as nickel, and have been successfully used for the vacuum distillation of beryllium. Actual zone refining using electron bombardment will be attempted shortly. At the present time, controls and actuators for zone refining are in the final stages of fabrication.

Preliminary experiments are now underway for purification of beryllium by vacuum distillation. In the initial work beryllium was deposited throughout the inside of the bell jar compartment, coating insulators and connectors, with resultant arcing problems. This problem was eliminated by proper shielding and experiments now are aimed at optimizing the electrode configuration to allow greater control of the vaporizing beryllium. There are presently underway investigations of configuration changes on the electron gun aimed at the following:

(1) Obtain operation of the gun at minimum filament temperature to reduce contamination.

(2) Obtain the narrowest possible molten zone.

(3) Control vaporizing beryllium so that contamination of the filament and loss of the material to the rest of the chamber does not take place.

ELECTRON BEAM APPARATUS FOR ZONE
LEVELLING W-Ta and W-Nb ALLOYS

by

D.P. Ferriss and R. M. Rose
Mass. Institute of Technology

Under sponsorship of the U. S. Army Ordnance Department, the Metals Processing Laboratory at M.I.T. is investigating the ductile-brittle transition temperature and plastic flow and fracture modes of W-Ta and W-Nb alloys. The electron-beam zone melting technique has been selected to provide specimens having minimum impurities. Zone levelling will be utilized to make the desired alloys from commercially available tungsten, tantalum, and niobium wire or powder.

At the present stage of the project, no experimental data can be reported; however, the electron beam apparatus will be described briefly together with pertinent comments which may be useful to others who may be undertaking or considering a similar endeavor.

The vacuum chamber is an 18-inch diameter bell jar, for visibility and simplicity, which rests with L-gasket on a 4-inch high aluminum ring. Containing 15 one-inch diameter ports, this ring permits access of any and all kinds to the system. Vacuum gauges, rotary or axial motion, electrical leads, instrumentation, etc. are readily installed through cover plates with O-ring seals. This structure rests on a 1-inch thick nickel-plated steel disc which is firmly supported structurally and whose only cut-out is a 6-inch diameter hole in the center for the diffusion pump line. A dove-tailed O-ring groove in the aluminum ring prevents the buna-N O-ring from falling out during assembly.

Pressures to 2×10^{-6} mm. of Hg have been obtained in the above system with a 6-inch oil diffusion pump baffled with a homemade liquid nitrogen, optically

opaque baffle and backed up with a 13 cfm. mechanical pump. A cold cathode ionization gauge was selected rather than risk contamination of a hot cathode by the several gases and vapors to be evolved from specimens during outgassing.

The specimen is held at ground potential in a water-cooled, copper frame with provision for rotating the top half of a specimen containing a molten zone while the bottom half may be moved axially, and independently, about one-half inch. These features permit, respectively, (a) testing for a complete molten zone across a section and (b) closing or spreading a molten zone during operation.

A number of electron gun designs have been tried with varying degrees of success, but the design has not yet been firmed. M.I.T. is fortunate to be cooperating with Alloyd Research Corporation in this endeavor and is looking forward to using the latter's gun design. The cathode supply is primarily a government surplus radar rectifier providing up to 15,000 volts negative at up to 500 milliamperes. Provision is also made for independent control of accelerator and repeller potentials over a wide range.

An initial decision to move the specimen and keep the gun stationary has very recently been reversed. An attempt to use teflon as flexible water leads was unsuccessful. Whereas teflon has a vapor pressure less than 10^{-6} mm. at tap water temperatures, experiment has shown that its solubility for water is sufficient to permit diffusion of water through the thin wall. Pressure was a distinct function of water pressure in the teflon tubing. A flexible arrangement of copper tubing proved awkward, and, all things considered, the decision was made to move the electron gun with movable electrical leads instead of movable water leads, and rotating one specimen half and advancing the other end with the requisite elaborate movable mechanism.

The Metals Processing Laboratory claims no credit for originating the above design features inasmuch as they are an amalgamation largely based on the experience of others. Our primary interest in electron beam melting is as a tool for the production of high purity alloys for metallurgical study.

STANDARDIZATION IN THE VACUUM INDUSTRY

by

W. G. Matheson, President-Elect
American Vacuum Society, Inc.

As many of you already know, the American Vacuum Society came into being as the successor to the Committee on Vacuum Techniques, which was first organized in 1953. From a small beginning, it has developed into a vigorous society dedicated to the dissemination of information to those interested in Vacuum Science and Technology. In partial fulfillment of our aims, we hold an annual symposium at which time about fifty technical papers are presented. These papers range from the fundamental type through applied science to industrial applications. About one-sixth of the program has been devoted to vacuum metallurgy. Many of these papers represent the latest developments both at home and abroad. Each year the symposium transactions are published in book form. These transactions have become invaluable as reference books.

At the 1958 Symposium we had papers on the same topic which has brought us together today, namely, the vacuum melting, purification, and fabrication of metals by means of an electron beam.

Our next symposium is to be held at the Hotel Sheraton, Philadelphia, October 7 - 9, 1959. At that time one or more sessions will be devoted to vacuum metallurgy. On behalf of Dr. C. R. Meissner, the 1959 Vacuum Symposium Program chairman, I extend to you an invitation to participate in our program. Your proposals for a paper should be sent to Dr. Meissner at the Bell Telephone Laboratories, Murray Hill, New Jersey for consideration by the Program Committee.

Another phase of our Society's work has been to evolve an acceptable Glossary of Terms for Vacuum Technology. Last year our Standards Committee was able

to publish this work and it is now available from Pergamon Press, Inc., New York. Continued work is being done in conjunction with the American Standards Association, the International Standards Organization, and the National Bureau of Standards. From these efforts will come a revised and complete Glossary of Vacuum Terms, which we hope will become universally accepted. I believe this is of interest and importance to all here today.

In closing, I would like to congratulate Mr. James Hetherington of the Alloy Research Corporation on preparing such a fine program and thank him for allowing me to be part of it.

AN ELECTRON BOMBARDMENT FURNACE
FOR THE PRODUCTION OF VACUUM-MELTED METALS

by

Ed. Candidus

National Research Equipment Corporation

Introduction

The stringent purity requirements which have been imposed on the reactive and refractory metals have made the melting operation a critical step in their preparation. Combination of electron bombardment heating with the cold mold technique has shown promise as a method providing both protection and purification during melting. As a result, work has been under way in several laboratories to determine the potential of this method and to design equipment for its utilization. This paper describes an approach which has been taken by NRC Equipment Corporation in the development of furnaces suitable for research and production melting of these metals.

Heretofore, the investment costs of an electron bombardment furnace have appeared to be higher than those of a conventional vacuum arc furnace because of a more costly power supply and the necessity of using a very high capacity pumping system. Operating costs have slow melting rates to achieve purification and to avoid electrical discharges in the vicinity of the melt. If melting rates are too fast to permit sufficient dissociation and volatilization of impurities, remelting of ingots is necessary (at substantially higher operating cost) in order to meet stipulated purity specifications.

The approach described here is based on recognition of the influence of these factors upon the economics of production melting. Efforts have been made to reduce these costs as much as possible, as well as to take advantage of other factors which make this type of melting more competitive (for example, the possibility of using non-consolidated metal powder or sponge as the melting stock).

Design Considerations

One of the chief difficulties encountered by workers in this field is gaseous discharge. Gases are generally evolved copiously during melting, and since the immediate area of gas evolution is ordinarily in the vicinity of a high intensity electric field, troublesome discharges result which may damage or even destroy the electron emitter and other parts of the apparatus.

There are several ways to overcome this difficulty. One is to utilize high speed pumps to keep the pressure below the discharge threshold in the face of gas evolution. Another is to tolerate the discharge and design the power supply to react instantly to the varying load conditions in order to avoid damage to the furnace components. A third method is to perform the melting in a field-free region; this last approach was chosen by us for reasons which are mainly economic. It will be seen that the power supply and pumping system, two items of major economic interest, are relatively cheap.

Melting in a field-free region can be accomplished by directing a beam of electrons from an electron gun to the melting area. All accelerating fields are confined to the vicinity of the electron emitter which is removed some distance from the work. The pressure near the melt can now be permitted to rise to much higher values than would otherwise have caused discharges, provided that the pressure in the vicinity of the gun is kept to values lower than the discharge threshold. This can be accomplished by isolating the electron gun in a separate vacuum chamber connected to the melting chamber by a small aperture or conductance, just large enough to allow passage of the electron beam. The gas flow into this section from the melting chamber can be brought to low values by good aperture design, so that only a small diffusion pump will be necessary to keep the pressure at the gun in the region of 10^{-4} to 10^{-5} mm Hg.

The elimination of discharges now permits the use of a smaller pumping system on the melting chamber and the use of a simple and relatively cheap power supply consisting of a transformer-rectifier combination with a minimum of protective and control features. The additional

pumping system required to evacuate the gun chamber costs little because of its small size, and is more than paid for by the reduction in cost of the main pumping system.

The first steps taken in exploration of the merits of the approach outlined above were the design, construction and operation of an experimental furnace for melting buttons.

Experimental Apparatus

Figure 1 is a diagram of the button melting furnace with which this concept was investigated. Figure 2 is a photograph of the equipment.

The melting chamber is a stainless steel bell jar 12 inches in diameter located directly above a 10 inch diffusion pump. A 10 inch slide valve separates the two components. The bell jar is wrapped with copper cooling coils and fitted with sight ports and an access port. A 6 inch diameter water-cooled copper block is supported inside the chamber and serves as a button mold.

There is a port on the top of the bell jar, directly over the copper mold, to which the electron gun assembly is attached. The central component of this assembly is a 4 inch diameter vertical copper tube, which has a side outlet leading to a 4 inch diffusion pump. The bottom of this tube is flanged and connected by a 4 inch air operated slide valve to the flange at the top of the bell jar. A Pierce-type electron gun of special design is bolted to a second flange at the top of the copper tube. In operation, a stream of electrons is fired downward through the tube and into the bell jar where it finally impinges on the metal to be melted, placed on the copper mold. The electron beam is focussed during its traverse of the tube by a solenoid, mounted externally. The tube is wrapped with copper cooling coils to prevent excessive heating by electron bombardment in the event that the beam is defocussed.

Production Furnace

After attaining operating experience of an encouraging nature in this experimental furnace, it was

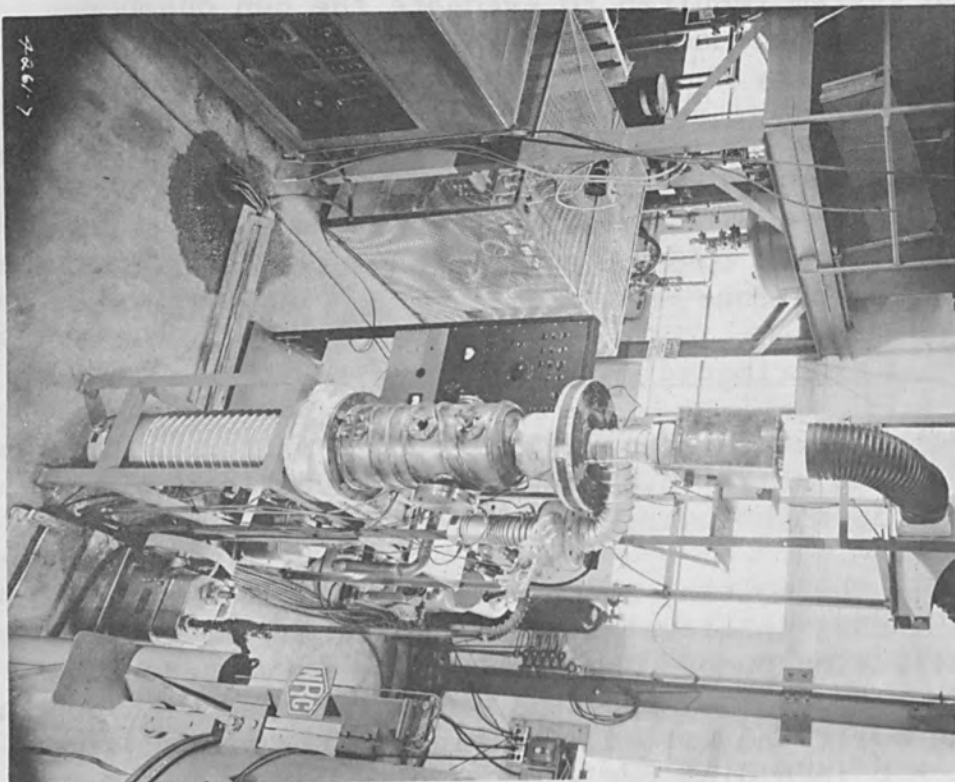

Figure 2
Button Melting Apparatus

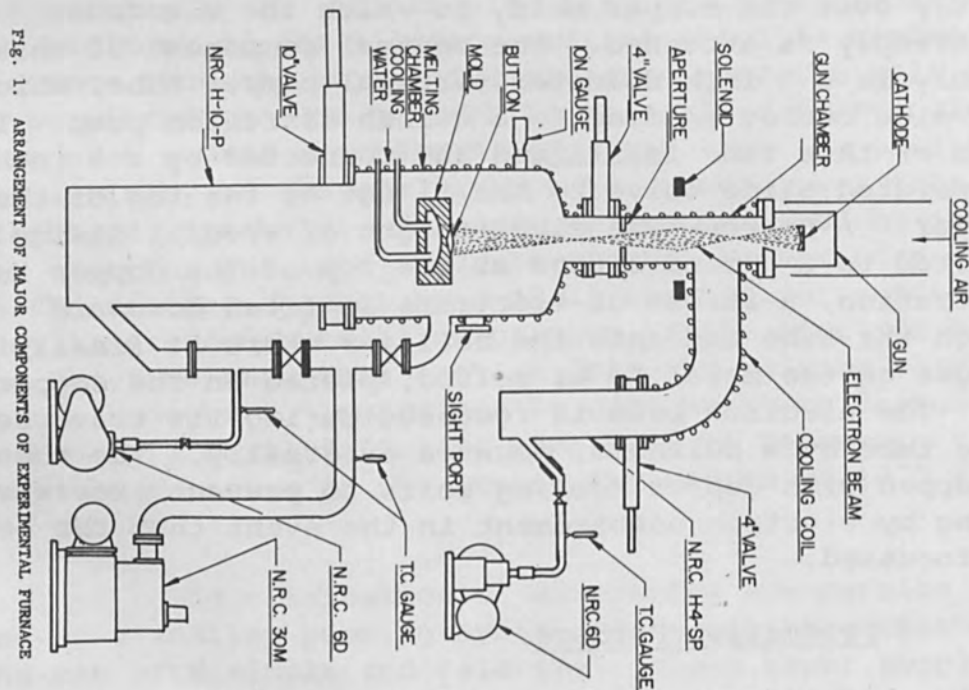

FIG. 1. ARRANGEMENT OF MAJOR COMPONENTS OF EXPERIMENTAL FURNACE

decided that the approach was worth while, and the design and construction of a 60 KW furnace was undertaken. The design parameter of chief importance here was the ability of the projected furnace to produce tantalum ingots 2.8 inches in diameter.

For the most part, the extension in design was a simple matter of adding a cold mold and ingot retracting mechanism to a unit very similar in design to the experimental furnace. The resulting package (shown in Figures 3 and 4) has a gun chamber and focussing system almost identical to that used on the experimental model. The melting chamber is a tank 18 inches in diameter with ports for a 10 inch pumping system, and a charging chamber. One direct view sight port is used for viewing the melt, and a tangential sight port is provided which can be used with a mirror if the direct view port is clouded by evaporated metal.

The pumping system is a 10 inch diffusion pump backed by a 100 cfm mechanical pump. Silicone oil is used as the diffusion pump fluid.

The charging chamber contains a hopper and vibrating trough arrangement. The hopper is loaded with granules of the metal to be melted, and the feed rate is controlled manually by varying the amplitude of trough vibrations.

The mold is a 2.8 inch diameter water-cooled copper liner in which the ingot stump can be raised or lowered by a feed screw arrangement. In operation, the molten pool is maintained at a constant vertical height - the operator drops a small amount of metal into the molten pool and then retracts the ingot a small amount. Eventually the operator will get a "feel" for the charging and retracting rates and leave them set at fixed values, making corrections from time to time.

In operation, several important things are noticed:

First, the metal generally evaporates rapidly enough at its melting point to provide a fresh film of clean metal on the walls of the melting chamber. These

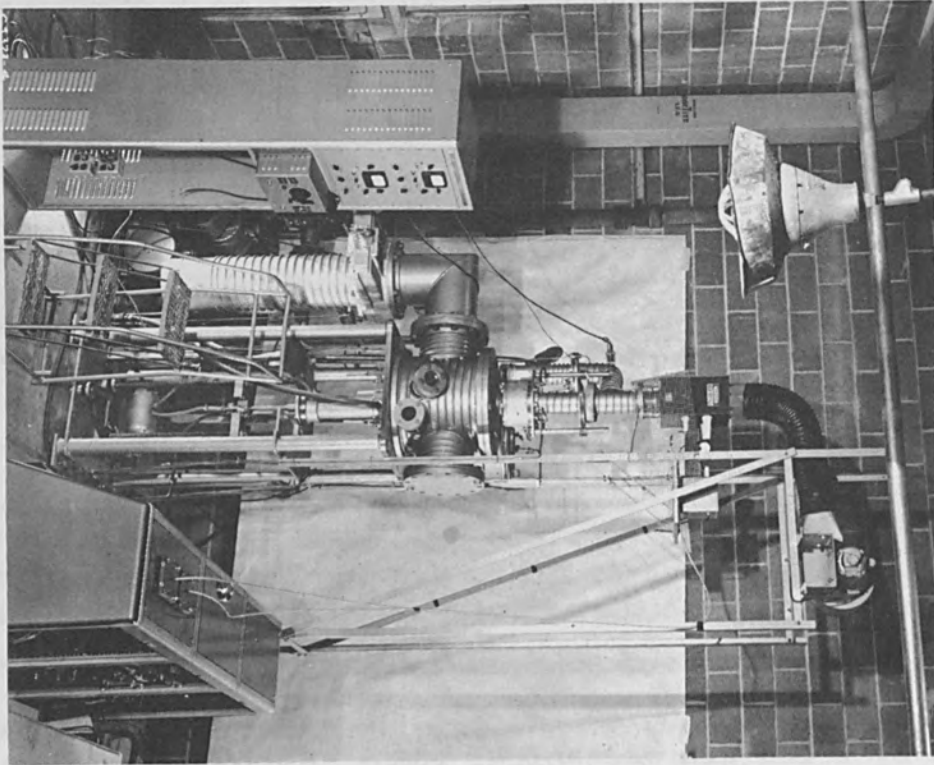

Figure 4
Production Furnace

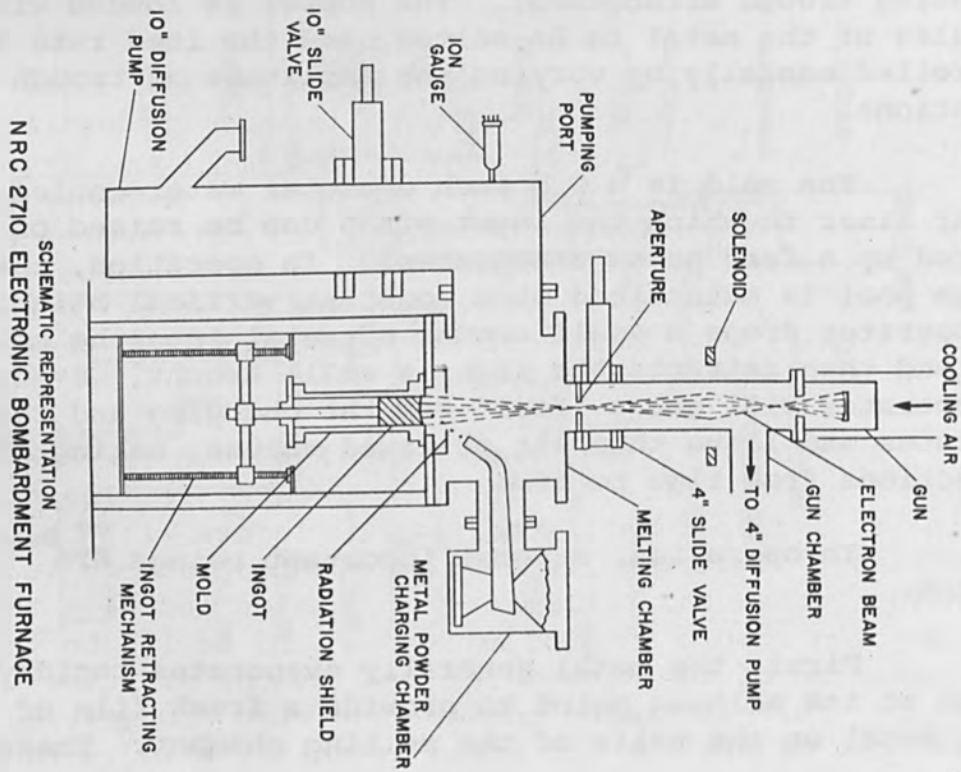

Figure 3

clean films are capable of pumping gases at a very high rate, and that this is indeed the case as shown by the fact that the 10 inch diffusion pump can almost be closed off without affecting the system pressure during a melting run.

Second, different metals behave as individuals, and a technique for melting each one must be developed by experience. Some metals, such as tantalum and columbium, are "good actors" in that they melt quietly, without much splatter, and can be allowed to "cook" for long periods of time at zero charging rate to purify them. Others we have tried, such as molybdenum, splatter and evaporate fairly rapidly, and the ingots should be grown at higher rates to avoid loss of metal. The situation can be alleviated somewhat by lowering the height of the molten pool, but this has the undesired effect of producing deposits on the mold wall above the melt which may eventually cause sticking when the ingot is raised or lowered.

Third, and perhaps most important, in all our melting experiments we have never seen a gaseous discharge—the well-known blue glow, and bane of the electron bombardment technique.

General Conclusions

Unfortunately, our efforts during the short time that this unit has been in operation have been devoted to perfecting the melting technique (producing sound ingots with good surfaces), and analytical data is somewhat sparse. However, the few analyses that have been made indicate that oxygen, nitrogen, and hydrogen contents in tantalum, columbium, molybdenum, and tungsten are drastically reduced. In some cases, the final analyses are beyond the sensitivity range of the measuring equipment.

These analyses, however sparse, are encouraging in that they were obtained in single melts, leading to the feeling on our part that remelting of ingots will be unnecessary. This results in a substantial saving in operating costs, and preliminary estimates indicate that this process should not add more than 10 to 15% to the selling price of tantalum metal used as the starting material. This is indeed competitive with arc melting, and we hope we are not far wrong in anticipating a rosy future for electron bombardment melting.

E-B MELTING OF Ti AND Ti ALLOYS

by

Stanley Abkowitz

Mallory-Sharon Metals Corporation

During the past ten months Mallory-Sharon has been working on WADC contract AF-33(616)-5603. The title of this contract is "The Electron Beam Melting of beryllium, Boron, Boron Carbide, Tantalum Carbide, Titanium Carbide, Tungsten and Zirconium Di-Boride". This contract is being monitored by the Materials Laboratory, Wright Air Development Center.

The program being covered by this contract will evaluate the capabilities of present electron beam melting technology in melting various materials. All melting thus far has been done at Temescal Metallurgical Corporation, Richmond, California. All materials have been melted except tungsten and some further beryllium ingots. We have prepared slides showing some of the materials melted.

The first slide shows tantalum carbide before and after electron beam melting. This picture is not a true indication of the condition of the 1-1/2 inch diameter button. The side not showing in this picture had incomplete fusion, and unmelted tantalum carbide particles can be seen.

The second slide shows zirconium di-boride before and after electron beam melting. This material vaporized as soon as it became molten. A heavy deposit was obtained on the furnace walls each time melting was attempted. No picture is shown of titanium carbide, but it reacted almost the same as the zirconium di-boride.

The third slide shows 1-1/2 inch diameter button of boron and various boron-carbide compounds (carbon shown in weight per cent). Since molten boron attacks tungsten it was necessary to use a carbon filament.



Slide 1

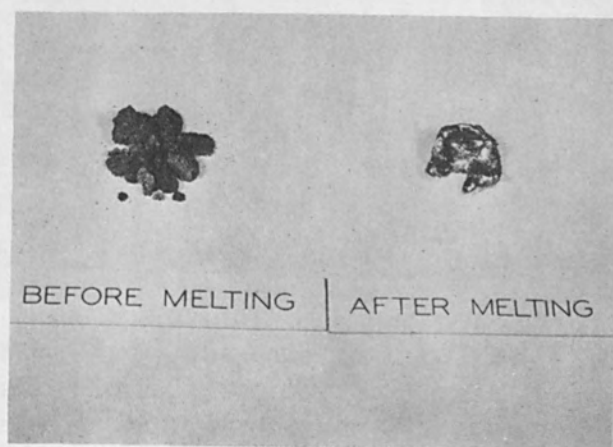

Slide 2

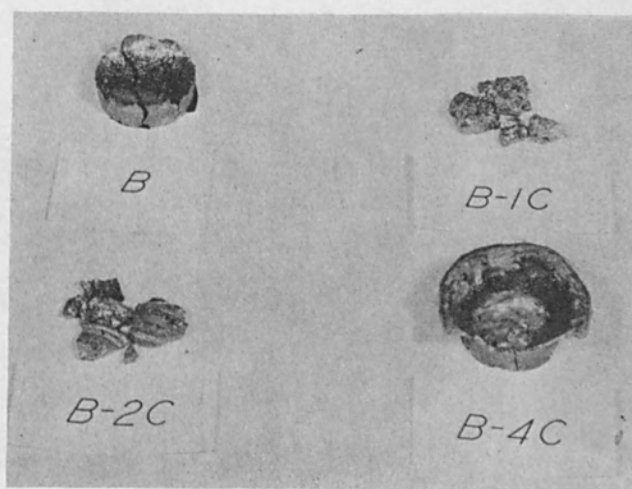

Slide 3

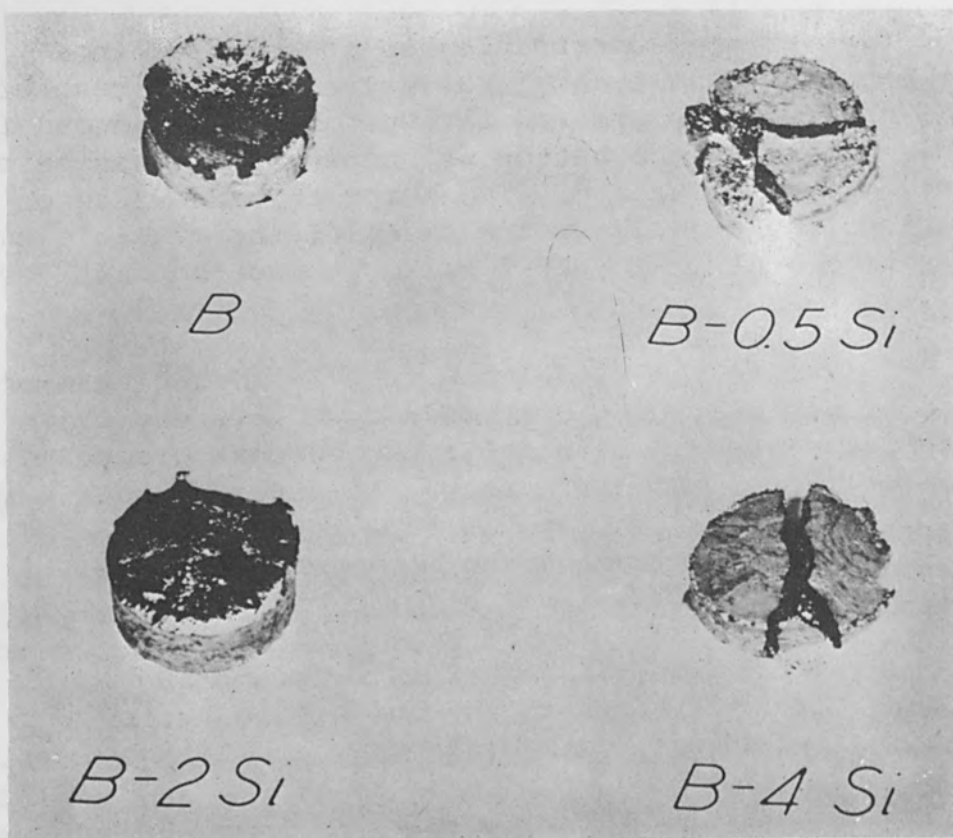

Slide 4

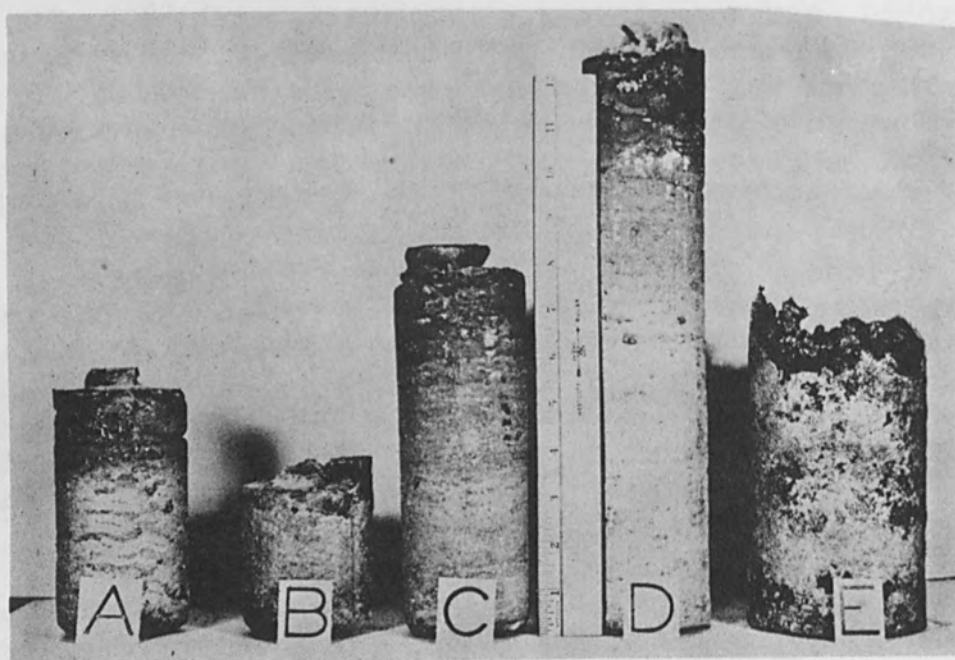

Slide 5

In addition a tapered crucible had to be used since boron expands as it cools. Extensive splatter resulted in all melting attempts and the best button produced is shown. Note that the button was broken as it was being removed from the furnace. The boron carbide mixtures had a tendency to walk up the sides of the crucible and form a high skull. The B-4% C alloy shows the skull very well.

The fourth slide shows the 1-1/2 inch diameter button of Boron-Silicon compounds made (silicon shown in weight per cent). Melting of these buttons proceeded reasonably well. Unfortunately, the final buttons were brittle and cracked on removal from the furnace. The B-2% Si button does not appear to be cracked, but it actually is.

Since there was considerable vaporization occurring during the melting of the B, the button very possibly is of exceedingly high purity. This will be determined.

The last slide shows four 3/4 inch diameter beryllium ingots which were melted in the electron beam furnace and one 4 inch diameter arc melted ingot (E). Melting of these ingots went extremely well. The ingots are going to be extruded to 3/4 inch x .35 inch at Nuclear Metals, Concord, Massachusetts. Melting loss due to vaporization does not exceed 12 per cent if melting practice is carefully controlled.

The tungsten has not yet been melted as was previously mentioned.

The major part of the contract is yet to come as all materials must be evaluated. This work is in progress but very little data is available as yet. It is possible that additional materials may be included under the present contract, but evaluation of material already melted will be completed first.

ELECTRON-BEAM FLOATING-ZONE MELTING
OF PLATINUM-GROUP METALS

by

W. P. Allred, R. C. Himes, and H. L. Goering
Battelle Memorial Institute

Introduction

As part of a research program on the properties of platinum-group metals sponsored at Battelle Memorial Institute by the United States Office of Naval Research, investigations of the effects of electron-beam floating-zone melting upon these metals are being conducted. This paper presents a brief account of this work including a description of the equipment which has been built at Battelle for such studies.

Experimental Equipment

The electron-bombardment system used in the floating-zone melting experiments is shown in Figure 1. The system is housed in a stainless steel jacket with view ports to make possible continuous observation. The rod to be treated is mounted vertically, supported at its end by stainless steel shafts which enter the vacuum system through silicone-grease packed vacuum seals. To bring a chosen portion of the piece into the beam, the supporting shafts are moved in their axial direction by a metal frame outside the system. The bottom shaft is fitted with a bearing inside the vacuum system, which allows the shaft to be rotated continuously during a run. Complete melting of a zone in the piece under study is signaled by commencement of rotation of the lower portion of the rod and its supporting chuck. Similarly, a freeze-up is signaled by cessation of this rotation.

A vacuum of 1×10^{-5} mm of Hg is maintained by a diffusion pump using silicone oil. A liquid nitrogen trap is mounted between the diffusion pump and the vacuum chamber.

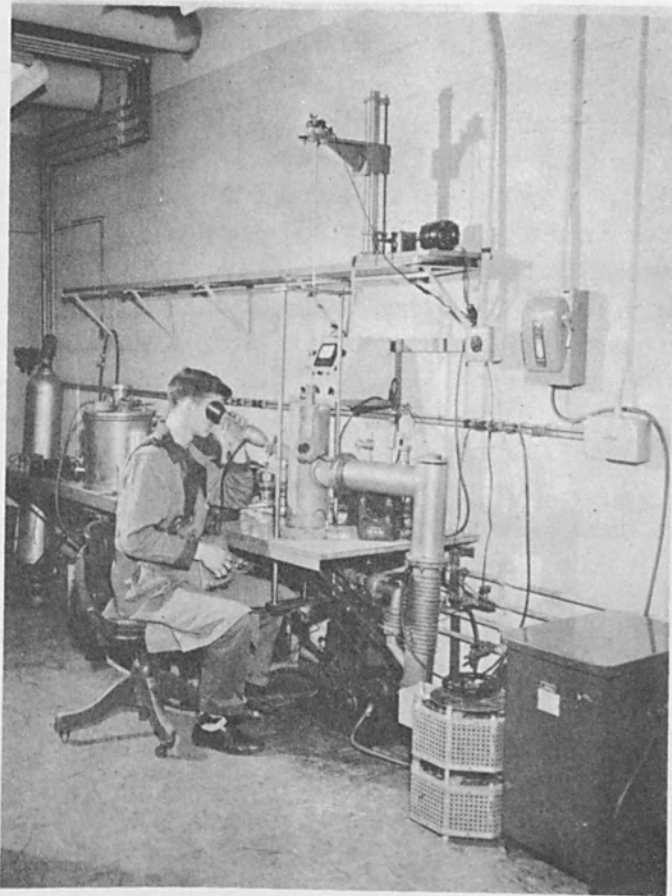

Figure 1

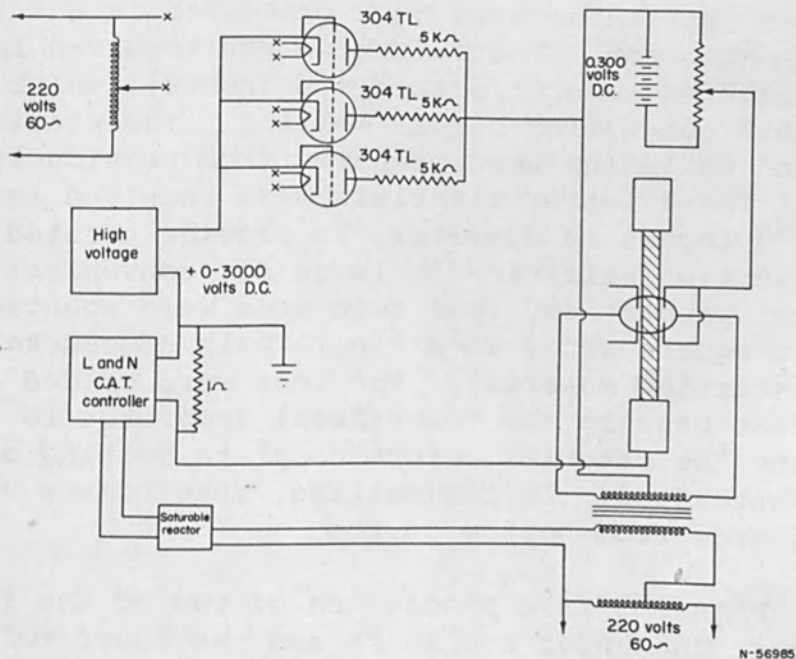

Figure 2

The electron gun is of a conventional design, using an annular tungsten ring as the filament and tantalum plates to focus the beam. Three 304TL triodes are connected in parallel to provide current regulation (Figure 2.) The tubes are used as diodes with the grids connected to the cathodes. The filaments are run at reduced temperature. Thus, the tube current is limited by the emission of the filament, and any change of plate voltage will have very little effect on the plate current. The bombardment current will therefore be dependent primarily upon the filament temperature of the 304TL's and not upon the resistance of the bombardment gap. This latter resistance may vary quite broadly and rapidly as occluded gases are set free in melting.

A Leeds and Northrup proportional controller, normally used to provide the very close control required for crystal growing, is used in the cathode circuit to correct for small variations of current and to compensate for variations of emission of the cathode due to cathode contamination. This controller controls the filament temperature through a saturable reactor in the filament circuit.

Floating-Zone Purification

To date, specimens of ruthenium platinum, rhodium, and palladium have been processed in the above described equipment. The ruthenium was received in the form of sintered rods (1/8 inch x 8 inches), which required considerable outgassing before melting. The platinum, rhodium and palladium were prepared from previously melted material. These latter materials were received as 10-inch rods, 0.150 inches in diameter. To provide treated samples of cross section sufficiently large for convenient study of physical properties, four such rods were mounted side by side in square array in a single pair of chucks, to form the starting material. The rods were welded together using a fast pass in the bombardment apparatus to consolidate the material before complete melting of a zone was attempted. In the melting, zone passes were generally made from bottom to top.

Figure 3 is a photograph of two of the ingots so prepared. The upper rod is Pt and the lower rod is Rh.

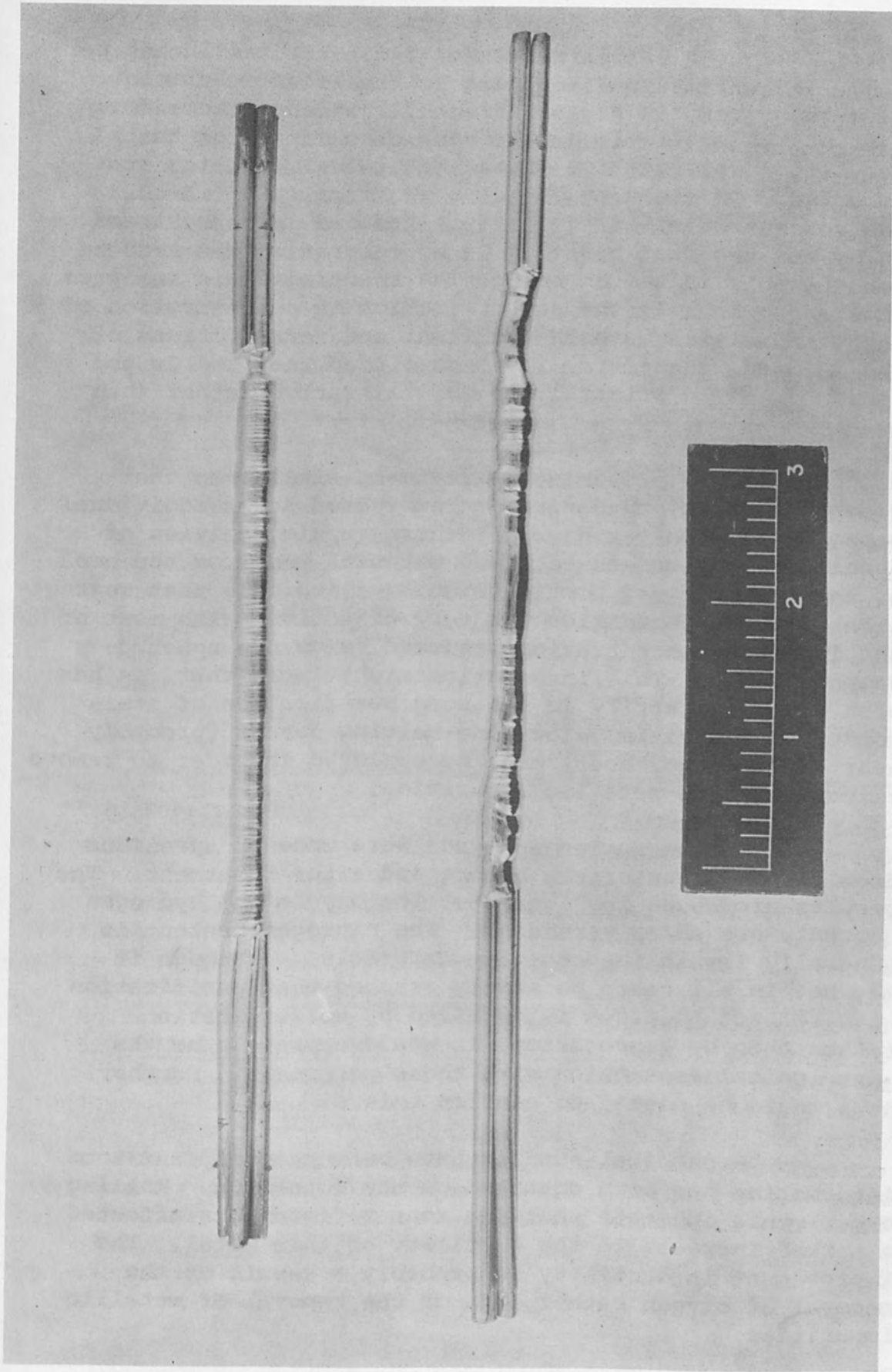

Figure 3

These rods were given two zone passes at three inches per hour. Spectrographic analysis were made on specimens from the materials as received and from the head and tail of the zone-melted sections. The data show that very little segregation of the metallic impurities occurred. Cu seems to be the only impurity of which the concentration is effectively reduced in both Pt and Rh by the two fast passes. Ca concentration was reduced considerably in the Rh only. The spectrographic analyses show approximately the same reduction in concentration of these impurities in both the front and rear sections of the ingots. Therefore, it is concluded that the Cu and Ca were removed primarily by volatilization rather than by segregation.

After preliminary treatment similar to that given Pt and Rh, ruthenium was subjected to an additional pass at 1/2 inch per hour. Spectrographic analyses of specimens from the as-received material and from the head of the zone-refined portion (Figure 4) indicate that segregation of metal impurities was very effective, with most of the impurity concentrations reduced below the spectrographic limit. This information might imply that, as has been found ordinarily in the zone purification of semiconductor materials, slow zone-melting passes (probably near 1/2 inch per hour) must be employed in order to remove effectively the metallic impurities.

Vacuum fusion analyses were made on specimens from the three materials before and after treatment. The results are shown in Figure 5. The oxygen and hydrogen contents are sharply reduced. The nitrogen content is generally low in the starting materials. Although it may not in all cases be safely assumed that purification with respect to gases is obtained by volatilization rather than by segregation, it would appear to be the most logical assumption with these materials. Further data would be needed to confirm this.

Mechanical studies have been started, and some information has been obtained on the ruthenium. Rolling experiments indicate that the zone refining has effected a marked increase in the ductility of this metal. The improvement in ductility is probably a result of the removal of oxygen rather than of the removal of metallic impurities.

It was found that Pd can also be zone-melted by electron bombardment although it presents additional problems because of its relatively high vapor pressure. Ir and Os are also to be studied in the present program. Data on these materials, as well as results of further studies on Pt, Rh, Ru, and Pd will be reported at a later date.

Figure 4. SPECTROGRAPHIC ANALYSIS OF RUTHENIUM

IMPURITY	IMPURITY CONCENTRATION, ppm		
	AS RECEIVED	FRONT	REAR
Os	Nd < 1000	Nd < 1000	
Pd	20-200	Nd < 5	
Rh	10-100	Nd < 10	
Pt	10-100	10-100	
Ir	100-1000	200-2000	
Fe	20-200	5-50	
Si and Cu	2-20	Nd < 10	
Au	2-20	2-20	
Sn and Pb	5-50	Nd < 5	
Ni	20	20	
Mg	2-20	1	
Mo	Nd	40-400	

Nd - NOT DETECTED.

Figure 5. VACUUM FUSION ANALYSIS

MATERIAL	TREATMENT	OXYGEN	HYDROGEN	NITROGEN
		ppm	ppm	ppm
RUTHENIUM	AS RECEIVED	3280	20	118
	SINTERED	63	0.4	<2
	ELECTRON MELTED	7	<0.2	<3
PLATINUM	AS RECEIVED	5	0.1	<2
	ELECTRON MELTED	<1	<0.1	<1
RHODIUM	AS RECEIVED	27	<0.2	<3
	ELECTRON MELTED	<2	<0.2	<3

ELECTRON BOMBARDMENT APPARATUS FOR ZONE-MELTING OF TUNGSTEN

by

J. L. Orehotsky, A. J. Opinsky
Sylvania Research Laboratories

Introduction

An electron bombardment apparatus for the floating zone-melting of tungsten rods has been constructed. The apparatus is similar to that described by Calverley, Davis and Lever ⁽¹⁾.

The Vacuum System

The vacuum system Figure 1, consists of a Pyrex cylinder two feet long and ten inches in diameter, two stainless steel plates, a vacuum valve, a Pollard conduction trap ⁽¹⁾, and a four-inch oil diffusion pump backed up by a rotary mechanical pump. The vacuum obtainable before melting is 10^{-5} mm Hg.

The Anode Assembly

The anode is 1/8 inch diameter tungsten rod clamped in a mild steel frame, Figure 1. The frame is supported from a stainless steel shaft which passes through the top plate and a double O-ring seal. A variable speed DC motor moves the whole anode assembly vertically. Zone traversal occurs by moving the anode with respect to a stationary cathode. The obtainable speed of traversal ranges from 0.05 to 2 inches per minute.

The Cathode

The cathode is a piece of 0.023 or 0.010 inch diameter tungsten wire bent into the shape of a single loop 1/4 inch in diameter, Figure 2. The wire, or filament, is clamped to two copper electrodes, Figure 3. The electrodes pass through the cylinder by means of

Kovar glass-to-metal seals. The focussing shield arrangement, the high voltage supply, and the emission control circuit are essentially the same as that of Calverley, et al. The cathode is at -2.5 KV, while the anode is at ground potential. The emission current required for zone purification is 0.3 amps.

Results

With this apparatus, up to 15 inches of 1/8 inch diameter tungsten rod have been zone refined, resulting in purified tungsten single crystals. The major source of trouble during zone purification of tungsten is the deposition of material from the molten zone on the filament, Figure 2. This affects the emission characteristics of the filament. Also, the life of the filament is shortened because the deposition occurs predominantly on the section of the filament directly exposed to the zone, leaving the relatively unexposed and uncoated section to eventually melt and burn out. The 0.010 inch filament usually lasts for one or two 12-inch zone refining passes before it burns out and has to be replaced. The 0.023 inch filament usually lasts for at least eight passes.

Determinations are being made of the content of molybdenum, oxygen, nitrogen and carbon in the refined zone; comparisons will be made with the composition of the original rod. Preliminary results are available only for molybdenum and carbon. The molybdenum analysis was done both spectrographically and by the radioactive tracer technique. The distribution of molybdenum was found to agree with Carlson's results⁽²⁾. The carbon analysis was made by chemical means and was found to be 80 ppm in the original unrefined rod, and 30 ppm in the zone purified rod near the first-to-freeze end.

Summary

An apparatus has been built for the floating zone-melting of tungsten rods. A deposition of material from the zone on the filament causes difficulties in maintaining constant emission characteristics and a long filament life. It is best to use large-sized filaments to avoid the problem of frequent burnouts. Preliminary data on the distribution of molybdenum and carbon indicate that purification is being obtained.

REFERENCES

1. A. Calverley, M. Davis and R. Lever, *Journal of Scientific Instruments*, 34 (1957) p. 142.
2. R. Carlson, *Journal of Electrochemical Society* 106, No. 1 (1959) p. 49.

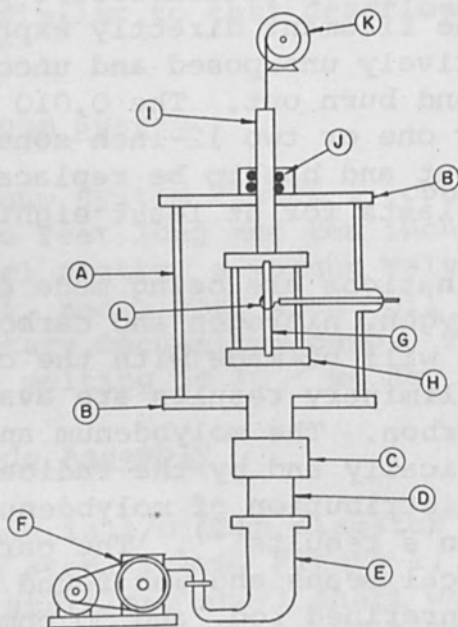

A	PYREX CYLINDER	G	ANODE
B	STAINLESS STEEL PLATES	H	FRAME
C	VACUUM VALVE	I	SHAFT
D	COLD TRAP	J	O-RING SEAL
E	DIFFUSION PUMP	K	D.C. MOTOR
F	MECHANICAL PUMP	L	CATHODE

Figure 1
Side View of Vacuum System,
Anode Assembly, and Cathode

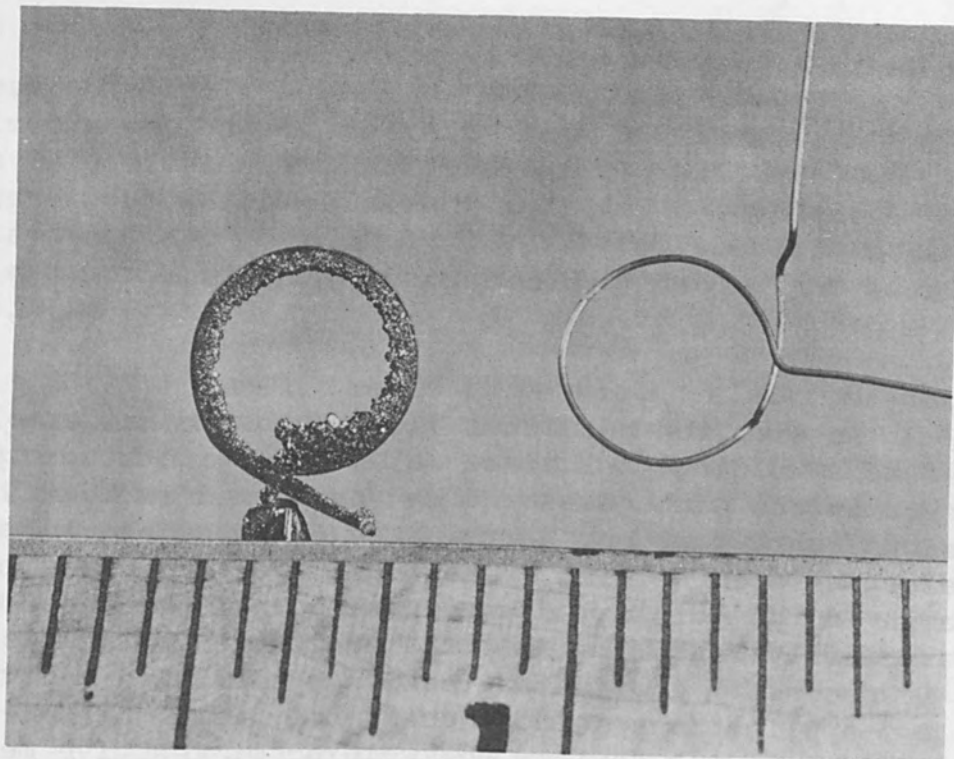
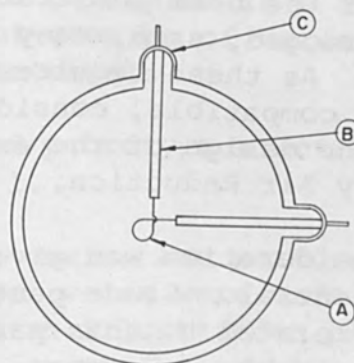

Figure 2
 A .010 Inch Diameter Tungsten Filament Before
 and After Two Zone Passes of a 12" Tungsten Rod



- A TUNGSTEN FILAMENT
- B COPPER ELECTRODES
- C KOVAR SEALS

Figure 3
 Top View of Pyrex Cylinder
 And Cathode Assembly

A LABORATORY PROTOTYPE ELECTRON-BEAM WELDER

by

A. Lesnewich

Air Reduction Company

An electron beam in a vacuum shows considerable promise as a welding tool since welds made with it are not contaminated with gases and can be varied in their dimensions; very deep but narrow welds are possible only with electron beam welding. The absence of any gases is desirable in the joining of hertofore unweldable metals that are easily contaminated. The control of weld dimensions is necessary in the fabrication of delicate apparatus. These two applications do not necessarily make the same demands of a welding device; the welding of reactive metals may require considerable power without too much control of its magnitude, whereas the joining of fine components may require very low power and precise control of the welding variables.

Therefore, a prototype unit should provide considerable variation in the beam voltage and current, control of the diameter of the beam at the surface of the work, and control of the beam position. At the same time, the unit should be rugged, safe, easy to operate, and simple to maintain. As these requirements of control and construction are not compatible, considerable compromise had to be made in the design of the experimental electron beam welder built by Air Reduction.

First consideration was given to the magnitude of accelerating potential. Since penetration of the weld nugget is directly related to this parameter, high voltages would seem to be desirable. However, high accelerating potentials create problems since x-rays are generated, electrical controls need to be more complex, the gun design is more critical, and electrical discharges are more likely to occur when metal vapors are released from the weld. A maximum potential of 15,000 volts was selected therefore to balance cost, safety and function.

On the basis of current requirements of most foreseeable applications for electron beam welding, a maximum power output of 7.5 kw was felt to be adequate; this is equivalent to a 300-ampere arc in inert-gas tungsten arc welding. The current is independent of the voltage and can be varied from zero to one-half ampere; it is controlled by the filament temperature and a grid bias.

The beam diameter is regulated electromagnetically. This control allows the separation between the gun and the workpiece to be varied while maintaining the smallest possible beam diameter. Although the best focus is obtained when the gun is closest to the work, the depth of focus becomes more critical when the two are close. In practice, the gun has been positioned between 5 and 8 inches from the work; considerable space is available for clamps and other devices needed to position the weld specimens.

The beam can be positioned laterally by electrical control to allow irregular seams to be followed.

The gun is mounted in a chamber that is evacuated before welding. The chamber contains a carriage for making linear welds or a turntable for making circumferential welds. The chamber and gun are evacuated with a 16-inch diffusion pump, a 6-inch booster pump, and a roughing pump. A high pumping capacity was considered to be desirable to allow the chamber to be evacuated in a short time and to handle large-volume out-gassing of welds made at high power levels in air-melted materials.

The assembled prototype electron beam welder is illustrated in Figure 1.

This welding device has performed much as expected. Using high power levels, welds were made in relatively large sections. Figure 2 is an illustration of a cross section of a lap weld in 1/8-inch stainless steel. The filler metal was obtained from the upper sheet. Welds such as this can be made only by spreading the beam over a relatively large area to heat both the upper and lower plate.

An example of a weld made at the other extreme of power input is shown by the photomicrograph in Figure 3. This is a cross section of a weld made in 0.005-inch stainless foil. In direct contrast to the other weld, needle-like focus is essential for such applications of the electron beam welder.

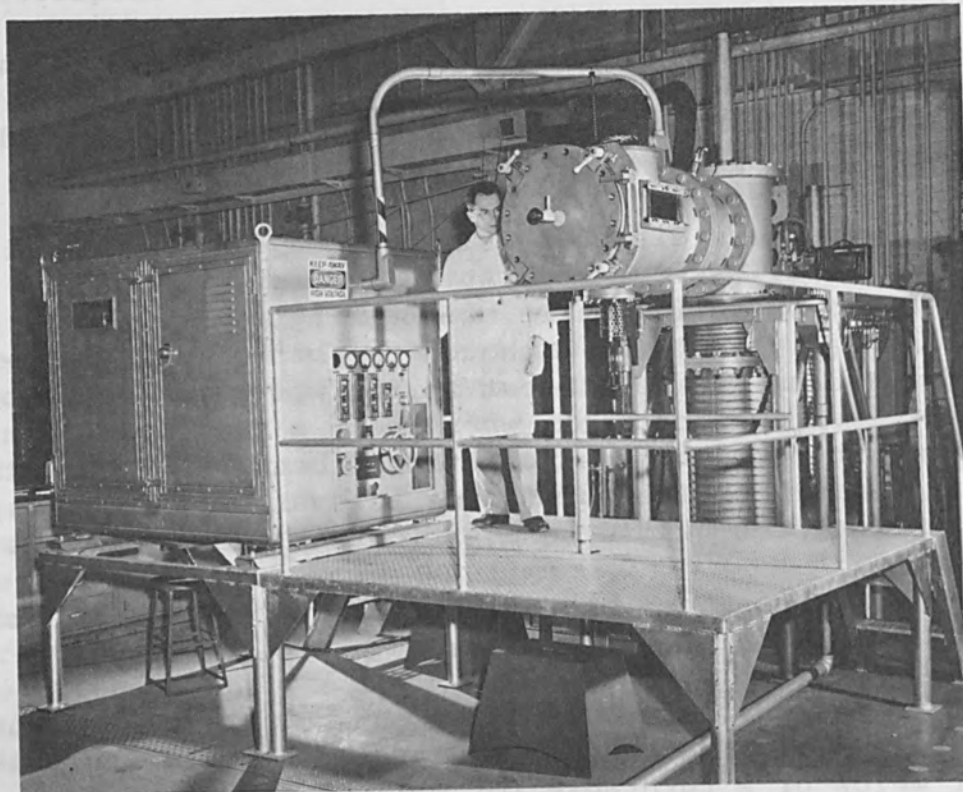

Figure 1

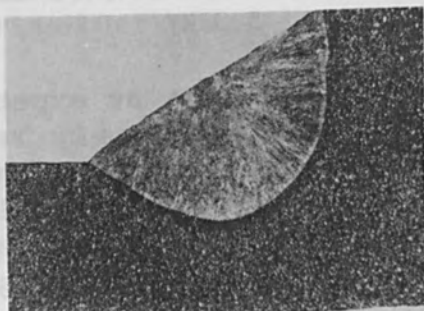

Figure 2

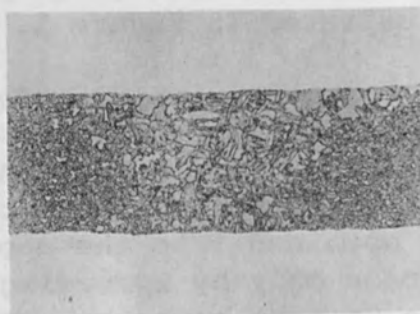

Figure 3

ELECTRON BOMBARDMENT MELTING OF TUNGSTEN

by

H. W. Schadler

General Electric Company

In the past three years, several authors have shown the advantages of electron beam heating both for the melting and purification of high melting point metals ^(1,2) and for critical welding applications. ⁽³⁾ Recently Carlson ⁽⁴⁾ has shown that electron bombardment zone refining can be used to produce high purity tungsten single crystals. Using a modified Calverley ⁽¹⁾ apparatus, we have been producing high purity tungsten single crystals in order to study the effect of purity on the mechanical properties of tungsten. This paper will describe first, the important characteristics of our electron bombardment zone refining equipment and second, some preliminary results on the effect of purity on the mechanical properties of tungsten.

EQUIPMENT AND CHARACTERISTICS

The electron bombardment melting equipment in use in our laboratory was designed for the floating zone melting of 1/8 inch rod stock. The essential features of the equipment are the electron emitter and the electric focusing plates, the vacuum system, and the power supply. The emitter configuration shown in Figure 1 is that which was found to be necessary for the successful melting of 1/8 inch tungsten rods. The same configuration has been used to melt tantalum and with minor modifications, boron, iron, and nickel. The rod to be melted is held rigidly at both ends in a vertical position and the emitter can be moved vertically by a rotating screw at speeds of from 0.1 to 100 millimeters per minute. Refining is accomplished by moving the molten zone down the rod at three millimeters per minute.

The vacuum system, which was built from standard components, has a capacity of 100 liter-microns per minute; and when the system is trapped with liquid nitrogen the

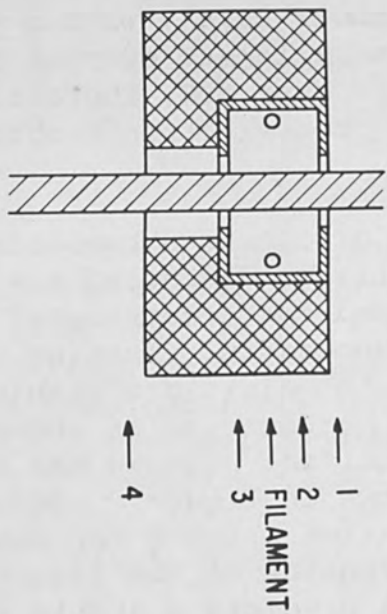
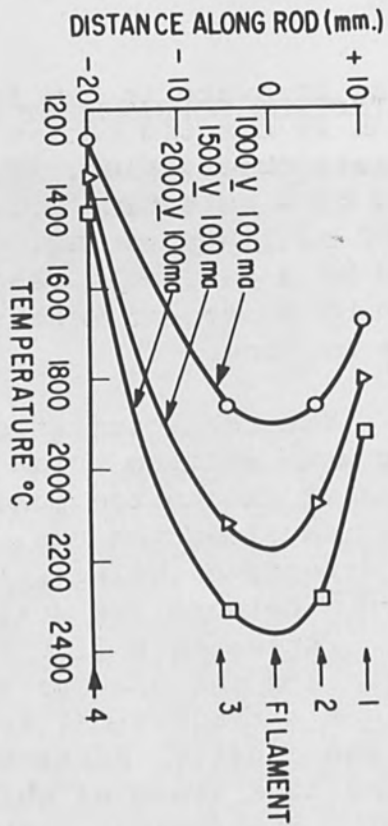

TEMPERATURE DISTRIBUTION ALONG 3 mm ROD
FOR VARIOUS POWER INPUTS

Figure 2

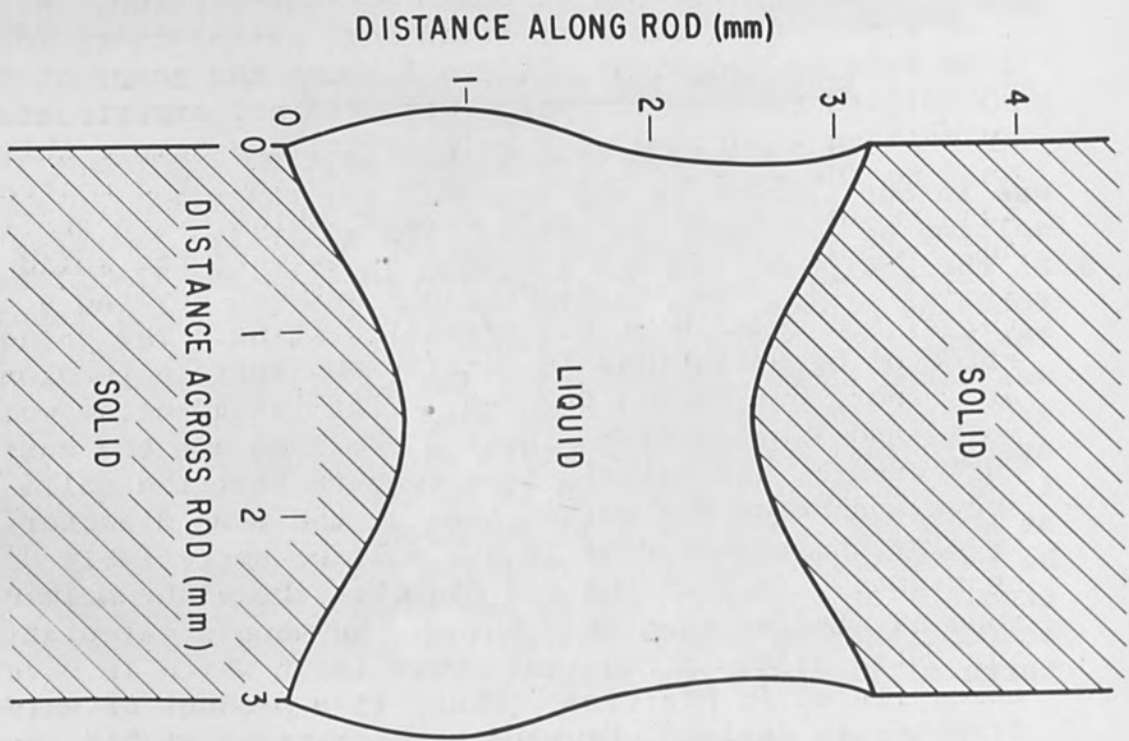

MOLTEN ZONE SHAPE IN A 3 mm ROD

Figure 1

operating pressure is 5×10^{-5} mm of Hg. The melting operation is carried out in a glass bell jar to facilitate observation. The accelerating voltage is supplied by a pulsating D.C. power supply with a 5000 volt, 300 milliamp rating. The filament current is supplied by a saturable reactor type A.C. controller designed by Rocco and Sears⁽⁵⁾ for electron bombardment crucible melting.

The characteristics of electron bombardment floating zone melting which will be discussed are; the shape of the molten zone and the temperature distribution along the rod. Successful floating zone melting depends on being able to maintain a stable molten zone between two solid surfaces as is shown in Figure 2. Assuming a flat interface between the solid and liquid and the contour shown in Figure 2, Heywang⁽⁶⁾ has derived a theoretical relation between the zone length, the density, surface tension of the liquid metal, and zone diameter which predicts a stable zone length of 9 millimeters for a 3 millimeter rod. In practice a 7 mm zone length has been used successfully, but the sample was not of uniform cross-section. A 3 mm zone length has been found most satisfactory for 3 mm rods of tungsten. Figure 2 shows the shape of the solidified molten zone which was obtained experimentally by melting a portion of a polycrystalline sample while holding the emitter fixed. Upon freezing, the molten zone solidified as a single crystal which, when sectioned and etched, revealed the boundary between the solid and liquid. The apparent discrepancy between Heywang's theory and experiment has several origins. The changes affected by variations in density and surface tension are minor, but Heywang assumed a flat interface between solid and liquid which Figure 2 shows is not the case. Furthermore, his calculations require that the solid above and below the molten zone be the same diameter or else the stable zone length will be appreciably shortened. In fact the rod diameter above the molten zone is smaller than that below. Heywang's calculation must also assume a constant power input which is never accomplished in practice. Thus, if a product of uniform diameter is desired, Heywang's theoretical stable zone length must be reduced by a factor of two or three in practice.

The temperature distribution along the solid rod in the vicinity of the molten zone is of interest for two reasons. First, the thermal stresses resulting from the temperature gradient influence the crystal perfection of the product; and second, diffusion of solute elements in the solid can reduce the efficiency of the zone refining process. Figure 1 shows the temperature distribution measured with an optical pyrometer along a 1/8 inch tungsten rod. The voltages and currents used are indicated. Higher temperatures were not attempted due to the vaporization of the metal onto the glass bell jar, but tungsten melts with an applied voltage of 2500 volts and a current of 225 ma. As can be seen in Figure 1 the temperature gradients are rather steep, being about 800-1000°C per centimeter. Tungsten and tantalum rods melted in this gradient solidify as single crystals. The tungsten crystals have six to eight sub-grains in a cross-section and a background dislocation density as determined from etch pits of 10^6 dislocation lines per square centimeter. Presumably, if the temperature gradient were reduced the perfection of the crystals would improve, but, within the limits of the equipment, changing the gradient has little effect on the dislocation density.

PURITY AND MECHANICAL PROPERTIES

Table I shows the major impurities which are present in tungsten rod both before and after zone melting. The starting material was supplied by the General Electric Tungsten Products Plant in Cleveland, Ohio and the analyses reported were done both by them and at the General Electric Research Laboratory.

Table I
Typical Analysis Impurities (weight %)

<u>Element</u>	<u>Starting Material</u>	<u>After Zone Melting</u>
Ca	0.001	N.D.*
K	0.004	N.D.
Na	0.002	N.D.
Fe	0.001	N.D.
Mo	0.004	0.0001
Si	0.002	N.D.
C	0.007 ± 0.002	0.002 ± 0.001
O	0.0003 ± 0.0005	0.0001
N	0.00003 ± 0.0001	N.D.
H	0.00001 ± 0.00003	No Analysis

*N.D. - Not Detected, i.e. 0.0001%.

Note the fact that of the common impurities present in tungsten, the only ones remaining after zone refining are carbon and molybdenum. Spectrographic analysis does not permit the detection of variations in molybdenum content along the length of the rod.

These analysis have been supplemented by resistivity measurements and measurements of the proportional limit**both in bending and in tension for several single crystals. Table II shows the variation in the ratio of room temperature to 4.2°K resistivity along the length of one single crystal which had been zone refined twice.

Table II
Variation of Resistivity Ratio Along Crystal No. 183

<u>Position in Single Crystal</u> <u>Measured from Starting End</u> <u>(cm)</u>	$\frac{\rho_{299.5^\circ\text{K}}}{\rho_{4.2^\circ\text{K}}}$
0	4300
0.6	5400
1.1	5200
3.1	3500
5.6	2800
8.2	2600
Starting Material	80

As is apparent, assuming that the resistivity ratio is a measure of the amount of impurity in solid solution, the crystal has been purified both by vacuum distillation and by zone refining. Comparing the resistivity ratio of the starting material with the zone melted material at a distance of 8.2 cm from the start of the zone refining pass shows that the amount of impurity present in solid solution has been reduced by a factor of thirty by vacuum distillation. Comparing the resistivity ratio at 0.6 cm and 8.2 cm shows that zone refining has decreased the impurities present in solid solution by an additional factor of two..Thus, it is apparent that purification of tungsten by electron bombardment zone refining is accomplished both by vacuum distillation and by zone refining.

** First detectable deviation of the stress-strain curve from linearity.

Information on the tensile properties of tungsten single crystals also show the same effects as are indicated by the resistivity data. Four single crystals of the same orientation (the first was used to seed the other three) but which were zone refined a different number of times were tested in tension. Two tensile specimens were taken from each crystal and Table III gives the proportional limit as a function of the number of passes and position along the crystal.

Table III

Proportional Limit as a Function of Purity

<u>Crystal No.</u>	<u>No. of Passes</u>	<u>Proportional Limit</u>	
		<u>Starting End (psi)</u>	<u>Finishing End (psi)</u>
160	1	38,000	40,000
159	2	34,000	37,000
158	3	30,000	32,000
157	4	17,000	---

The effect of vacuum distillation is not as apparent from these data as from the resistivity data, but the decrease in the proportional limit at the finish end of the zone refining pass as the number of passes is increased is ample proof that vacuum distillation is an important means of purification. The difference in the proportional limit of the two samples taken from the same rod again indicates that zone refining is also an important method of purification. One further set of data also indicate that zone refining is actually occurring. Sample No. 126 was zone refined twice, cut into four bend samples and the proportional limit measured in four point bending. The data are given Table IV, and it is apparent that the proportional limit increases from a position in the crystal near the start of the zone refining pass to one at the finish. The differences in the stress level of the data in Tables III and IV can be attributed to the difficulty of determining the earliest deviation of the stress strain curve from linearity in a bend test.

Table IV

<u>Position in Crystal (inches)</u>	<u>Maximum Fiber Stress at Proportional Limit (psi)</u>
1/4 - 1/2	78,000
1 5/32 - 1 13/32	79,000
1 7/8 - 2 1/8	82,000
2 7/8 - 3 1/8	98,000

SUMMARY

Electron bombardment floating zone refining can be used for the purification of tungsten and the growth of tungsten single crystals. Measurements of electrical resistivity and mechanical properties of tungsten single crystals indicate that purification is accomplished both by vacuum distillation and by zone refining.

REFERENCES

- (1) A. Calverley, M. Davis, and R. Lever, *J. Sci. Instr.* 34, 142 (1957)
- (2) H. Smith, C. d'A Hunt, C. Hanks, *J. Metals* 11, 112 (1959).
- (3) W. L. Wyman, *Welding Journal*, 37, 49 (1958).
- (4) R. G. Carlson, *J. Electrochemical Soc.*, 106, 49 (1959).
- (5) W. Rocco and G. Sears, *General Elec. Res. Lab. Report* 55-RL-1399.
- (6) W. Heywand, *Z. Naturforsch*, 11A, 238 (1956).

PRODUCTION OF RODS FROM FINELY DIVIDED SILICON²⁸
ISOTOPE BY ELECTRON BEAM MELTING

by

E. Buehler

Bell Telephone Laboratories, Inc.
Murray Hill, New Jersey

It has been predicted that the Si²⁹ isotope in natural silicon is responsible for the line width of the paramagnetic resonance absorption of unionized donors in silicon. In addition, it has been pointed out that a phosphorous doped crystal of silicon in which the concentration of the Si²⁹ isotope had been lowered to only a few tenths per cent could probably be operated as a maser.

A 5 gram sample of material containing 74.5 per cent silicon by weight of isotope abundance $99.93 \pm .02$ Si²⁸ (a) was obtained from the Oak Ridge Laboratories of the A.E.C. The mass spectrometer ion beam had been collected on graphite plates, the silicon removed by chlorination, the tetrachloride hydrolysed, and the SiO₂ reduced with magnesium in a thermite reaction. The material which was recovered after leaching in H₂SO₄ and in HF solutions was a dark brown powder which proved to be equal mole amounts of Si and SiO₂.

An earlier attempt to prepare a single crystal of Si²⁸ resulted in the growth of a crystal about .08 inches in diameter, .6 inches long weighing 150 milligrams. This was recovered from another isotopically enriched sample (99.5% Si²⁸) obtained from the Oak Ridge Laboratories and was also a mixture of Si and SiO₂. A number of separation and recovery schemes were proposed and tried, but the amount of Si recovered was insufficient to enable refining operations to be carried out which would have lowered the impurity concentrations to acceptable limits. It was planned to use this crystal as a seed in subsequent work on the preparation of a larger isotopically enriched single crystal.

(a) Natural silicon contains 92.8% Si²⁸, 4.67% Si²⁹ and 0.05% Si³⁰.

The recovery scheme was developed by C.D. Thurmond.² It centered around the use of aluminum as a reducing agent and the use of tin as a solvent. It was found that the silicon could be recovered after the aluminum reduction by dissolving away the excess in aqueous HCl and dissolving the recovered silicon in molten tin from which it could be precipitated as usable crystallites by slowly cooling the melt. The crystals were recovered from the melt by dissolving the tin in hot aqueous HCl. Approximately 91 per cent of the available Si²⁸ was recovered.

Rods suitable for zone refining were formed by a dipping technique, one from a control sample, the other from the Si²⁸. These were made in the vacuum floating zone apparatus using a special fixture under the bell jar. Figure 1 shows a schematic drawing of the equipment. The procedure for forming a rod was as follows.

A seed crystal, mounted on a movable carriage was heated at its lower extremity by electron bombardment. A droplet of liquid formed at the end of the seed, supported by surface tension. The granular silicon, held in a commercial grade fused quartz cup, was brought into contact with the droplet by raising the cup. Upon lowering the cup, those particles which adhered were fused into the melt. By raising and lowering the cup and at the same time withdrawing the seed from the heating zone, a rod was formed with minimum contamination.

This procedure was followed in forming the Si²⁸ and the control sample rods until about 7/8 of the material had been removed from the quartz cup. The container was then refilled and the formation of the rod continued. At no time did molten silicon make contact to the quartz vessel.

It was necessary to employ two kinds of heating to add material successfully to the Si²⁸ seed since the seed was small. At 3.5 megacycles (r.f. generator frequency) it has not been possible to maintain a stable melted droplet on a rod of silicon less than 5/32 inch in diameter. Therefore, to concentrate the heat on the small seed, and to maintain a reasonably small droplet, electron bombardment heating was used until a larger diameter (greater than .200 inch) was acquired. Thereafter the r.f. heating

ALTERNATE HEATING
METHOD
TUNGSTEN FILAMENT
FOR ELECTRON
BOMBARDMENT

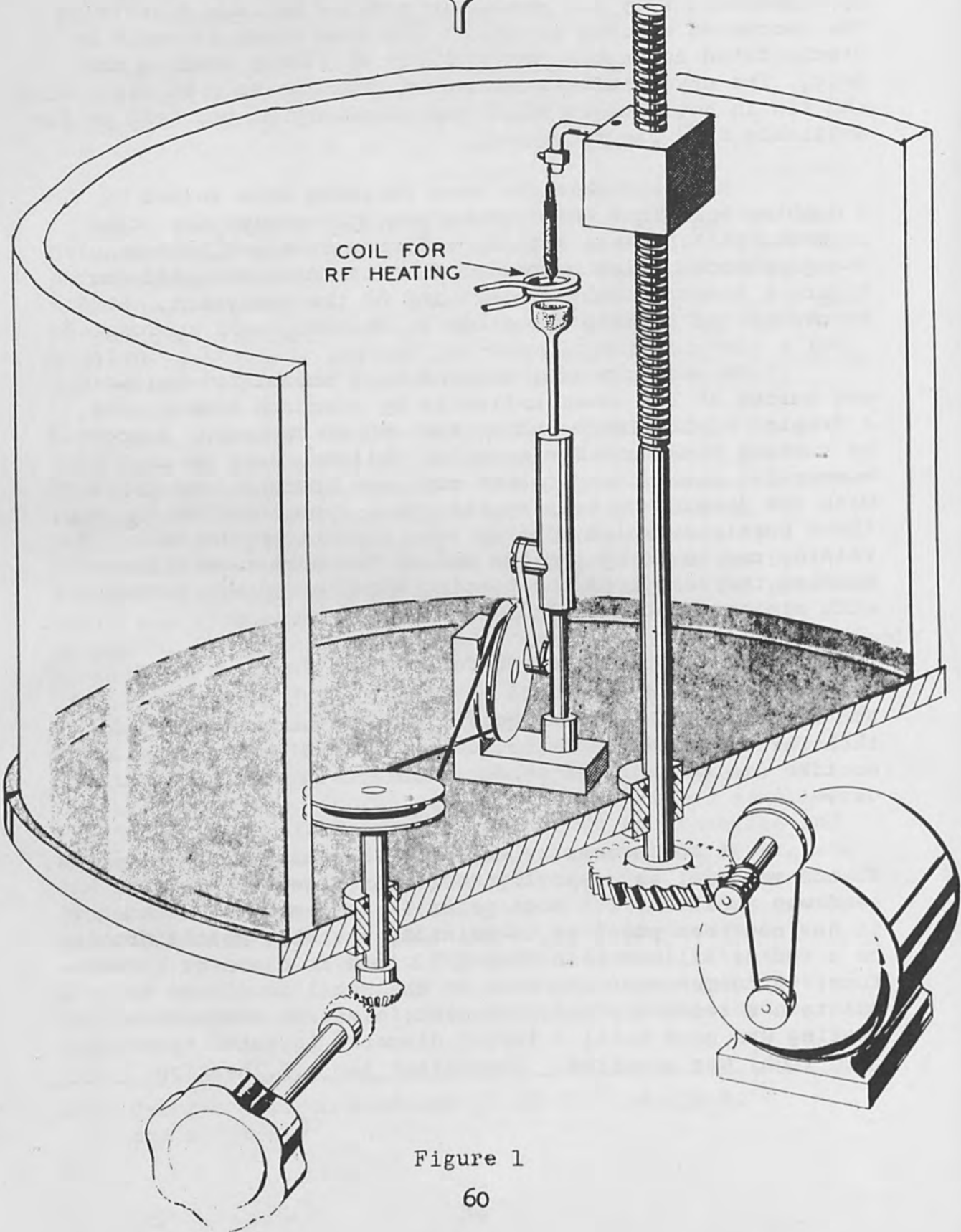
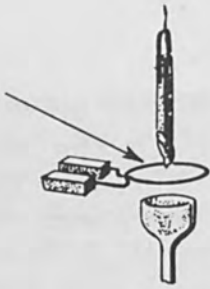

Figure 1
60

proved very satisfactory. Both the control sample and the actual Si^{28} were handled in the same way, heated first by electron bombardment from tungsten filament, and then heated by r.f. currents. About 1/12 of the total volume of a rod was heated by electron bombardment.

After forming each rod, a low resistivity boron doped natural silicon "tail end" was added by a fusion weld. They provided a low resistivity region for starting the r.f. heating and a support at the finishing end of the rods during refining operations.

Zone refining was done in wet and dry hydrogen under the bell jar at absolute pressure, ranging between 450 and 550 mm. Hg. The wet hydrogen was required to remove the boron from the silicon. Special care was exercised to avoid re-entering the low resistivity boron doped tail end sections with the molten zone. Resistivities after refining were from 2 to 10 ohm cm p type.

The rods were then doped with phosphorous which was introduced by diffusion. This was done by an open tube process, by C.J. Frosch ⁽¹⁾. Final resistivities after making two passes in vacuum ranged between .4 and .2 ohm cm n type. Most of each rod was a single crystal.

Spin resonance experiments were carried out by G. Feher ⁽²⁾ and J. Gordon on the seed end half of the crystal. It was found that the resonance line had decreased in width from 2.7 gauss to 0.22 gauss. This width was sufficiently narrow to meet the conditions for maser action and oscillation was observed.

REFERENCES

- (1) Journal of the Electro-Chemical Society, Vol. 104, pp. 547-552, Sept. 1957.
- (2) Phys. Rev. Vol. 109, pp. 221, Jan. 1958.

CONVERSION OF A CONSUMABLE ARC MELTING
FURNACE TO ELECTRON BEAM MELTING OF TITANIUM

By

L. L. France

Westinghouse Electric Corporation

The project of modifying a consumable arc melting furnace for consumable electron beam melting was undertaken to gain experience in this field and to ascertain design information necessary for the construction of apparatus solely for electron beam melting. This converted unit was not necessarily intended to serve as an entirely satisfactory electron beam melting unit but was convenient in obtaining preliminary data concerning this melting technique.

The requirements for consumable electron beam melting and casting can be summarized as follows;

- (1) A power supply, normally high voltage (5 - 20 KV) and rather low current (1 - 20 amperes)
- (2) Suitable controls and protective devices for the power supply ie.
 - (a) Current limiting device, if necessary
 - (b) Filament emission temperature control
 - (c) Protective devices ie. fuses or circuit breakers
- (3) A vacuum system capable of maintaining a dynamic pressure of less than 1×10^{-4} mm Hg during melting. The required pump capacity is determined by the material to be melted, its impurity level and the leak rate of the system.
- (4) A suitable mold assembly, generally a retractable water-cooled copper mold.

- (5) Sufficient internal volume to contain the electron source (gun) together with the necessary mechanical supports and electrical leads. Also a convenient entrance lock for inserting and removing the gun assembly for repairs and "focusing".

These requirements will vary somewhat depending upon the intended application.

Many of the requirements listed above are not normally found in conventional arc melting furnace. The melting chamber usually is not large enough to house the additional apparatus required for electron beam melting. Accessibility to this chamber for inserting and removing the "gun" assembly is limited, if at all possible. The vacuum systems used with arc melting furnaces are designed to have the maximum thru put in the pressure range of from 10^{-2} to 10^{-3} mm of Hg.

The arc melting furnace used for this work is shown schematically in Figure 1. Certain features of this unit are not conventional but a detailed description of the furnace is not required for the present purpose. The port used as an entrance lock for the electron gun assembly was originally intended for an additional diffusion pump. The 10-inch diameter of this opening was the limiting factor on the size and flexibility of the gun design. A single gun system was necessitated because of space limitations, through a two gun system is more desirable for the configuration used in this work.

The complete gun assembly is shown in Figure 2. This unit, while being convenient to insert and remove from the system, is rather complex in design and quite fragile. The gun is shown in detail in Figure 3. It is rather conventional in design, the shell being stainless steel with molybdenum "focusing" plates. This design does not permit biasing of these plates, however, this could easily be arranged, if necessary. The filament is .05 inches diameter W wire. Because of the tendency for the filament to sag while at high temperatures the four support wires were required.

Identification of Parts of Versatile Arc Furnace

Shown in Fig. 1

1. Entrance Lock for Electron Gun
2. Melting Chamber
3. Water Cooled Retractable Mold
4. Electrode Housing
5. Electrode Drive Assembly
6. Liquid Nitrogen Baffle
7. Diffusion Pump - 10" Lebold OT 1800
8. Sight Port
9. Sight Port
10. Mechanical Pump - Kinney KDHL 30
11. Furnace Support Frame
12. Furnace Bearings

452JEB9

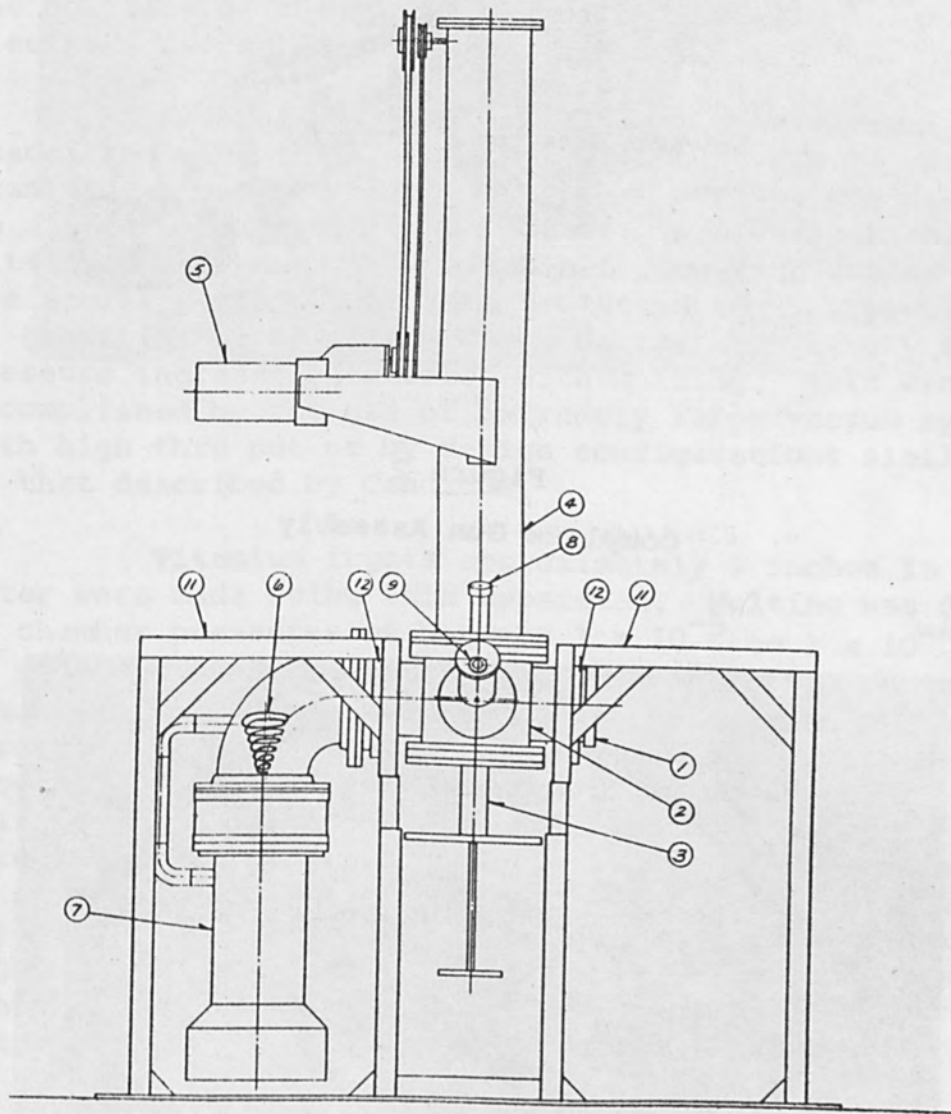

FIG. 1
SCHEMATIC OF VERSATILE ARC FURNACE
FRONT VIEW

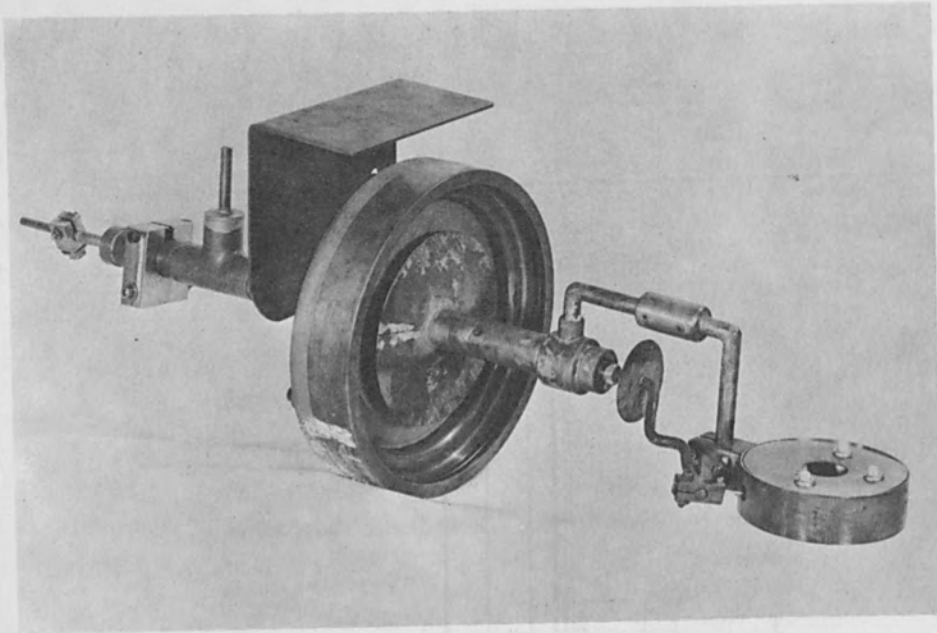

Figure 2
Complete Gun Assembly

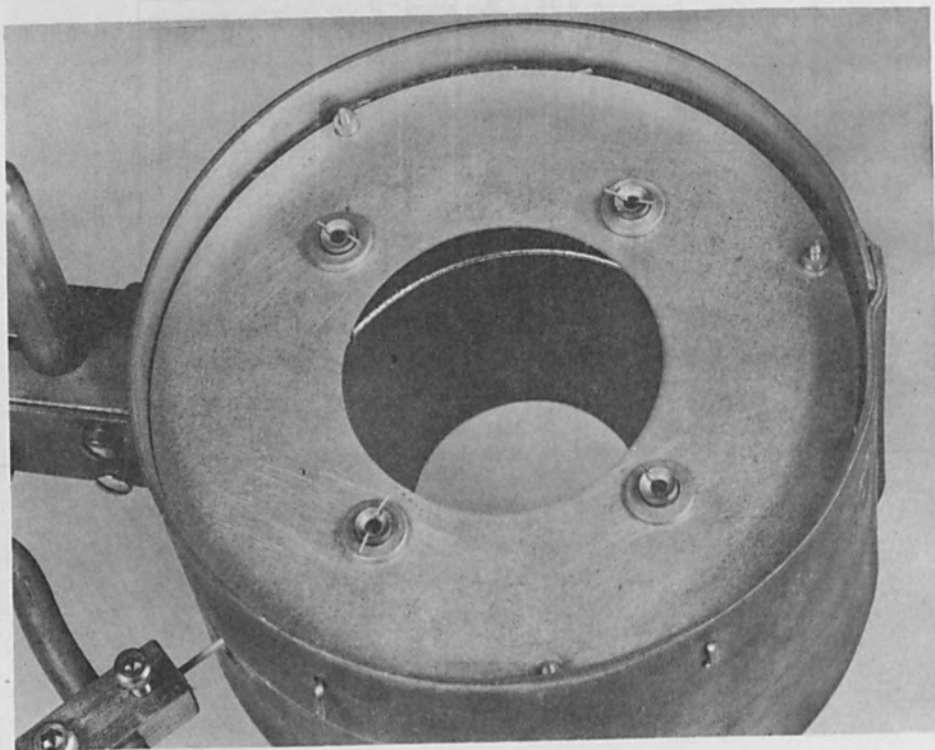

Figure 3
Electron Gun Detail

The power supply used for this preliminary work was a three phase full wave rectification unit rated at 10 KV and three amperes. The operating voltage was manually preset by means of variacs on the 440 volt three phase input. The melting current was controlled by varying the filament temperature and the position of the gun in relation to the consumable electrode and mold.

Several schemes to limit the high currents associated with the low voltage arcing phenomena were examined. However, current limiting devices contribute to an inefficient use of the available power, in that little if any power is available for melting during the arcing period. The ideal solution to this problem is the elimination of the cause of the arc, namely the pressure increase associated with melting. This can be accomplished by the use of extremely large vacuum systems with high thru put or by design configurations similar to that described by Candidus.

Titanium ingots approximately 2 inches in diameter were made using this apparatus. Melting was done at chamber pressures of between 1×10^{-5} to 1×10^{-4} mm of Hg. The electrodes melted were commercial 7/8 inch diameter arc melted titanium rod. The melting of this electrode is shown in Figures 4, 5 and 6. Figure 4 shows the electrode being heated prior to the start of melting. The electrode with a molten drop about to fall into the molten pool is shown in Figure 5. The electrode is shown in Figure 6 just after a drop has fallen into the mold. This series of pictures was taken through sight port 9 in Figure 1. A view of the molten pool contained by the water-cooled mold is shown in Figure 7, this photograph was taken thru port 8, Figure 1.

The 2 inch diameter titanium ingots required a power of about 10 KW. (7KV and 1.4 - 1.5 amps) to continuously melt and cast. To maintain only the pool molten required between 6 and 7 KW (7 KV and .9 amp) while melting only the electrode required approximately 3 KW.

A typical titanium ingot melted as indicated is presented in Figure 8. The surface condition of this ingot is reasonably good except for the starting section.

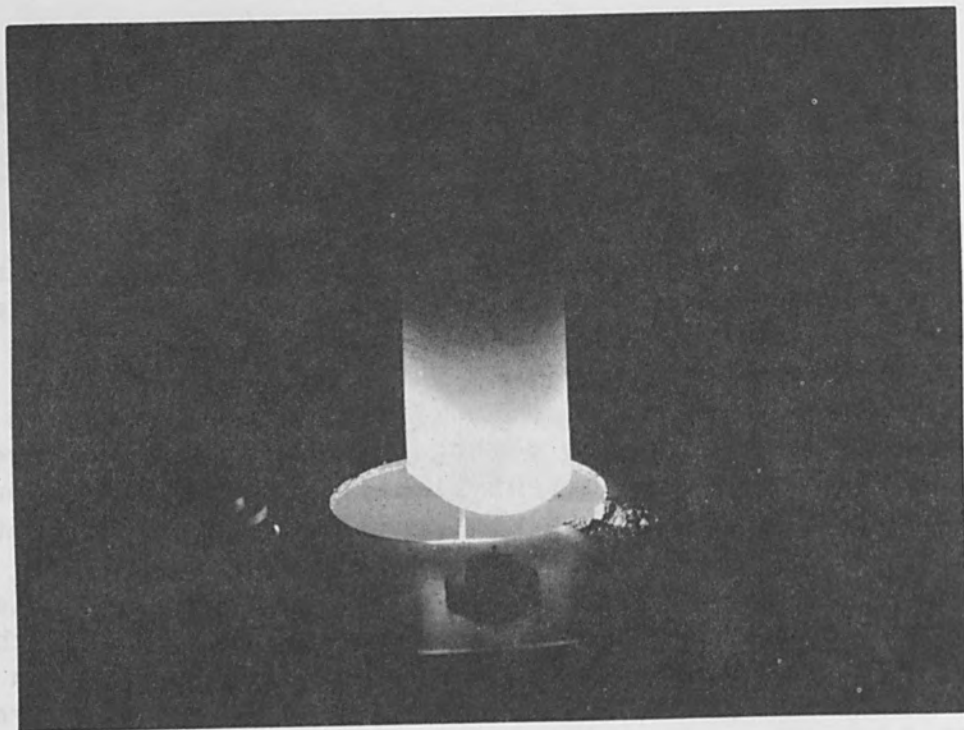

Figure 4
Titanium Rod Under
Electron Bombardment

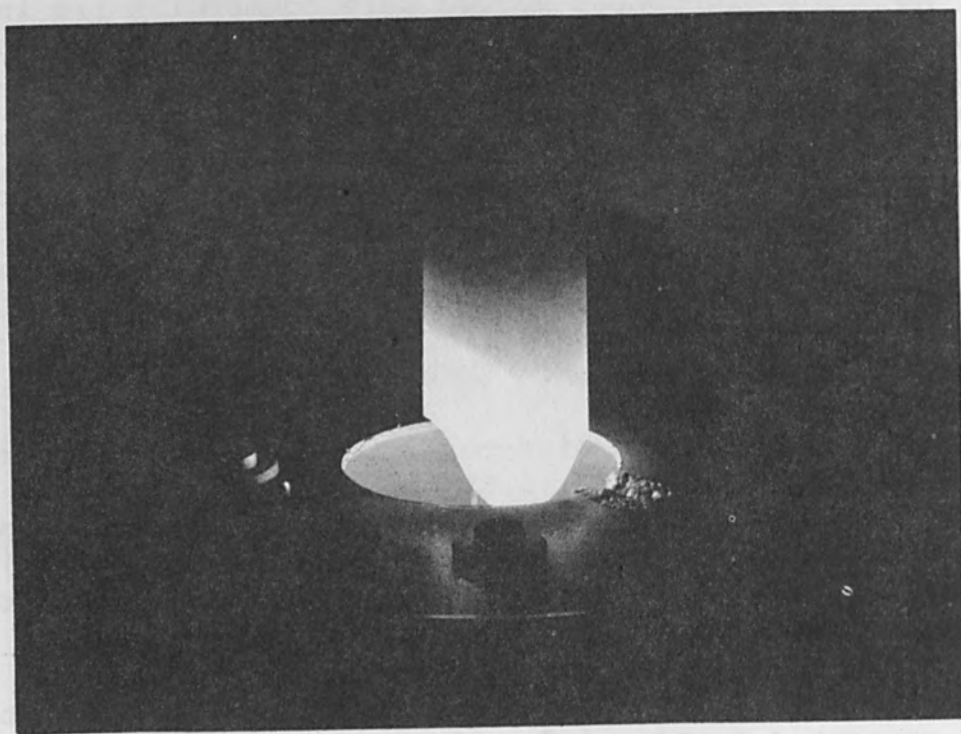

Figure 5
Droplet Forming On
Titanium Rod

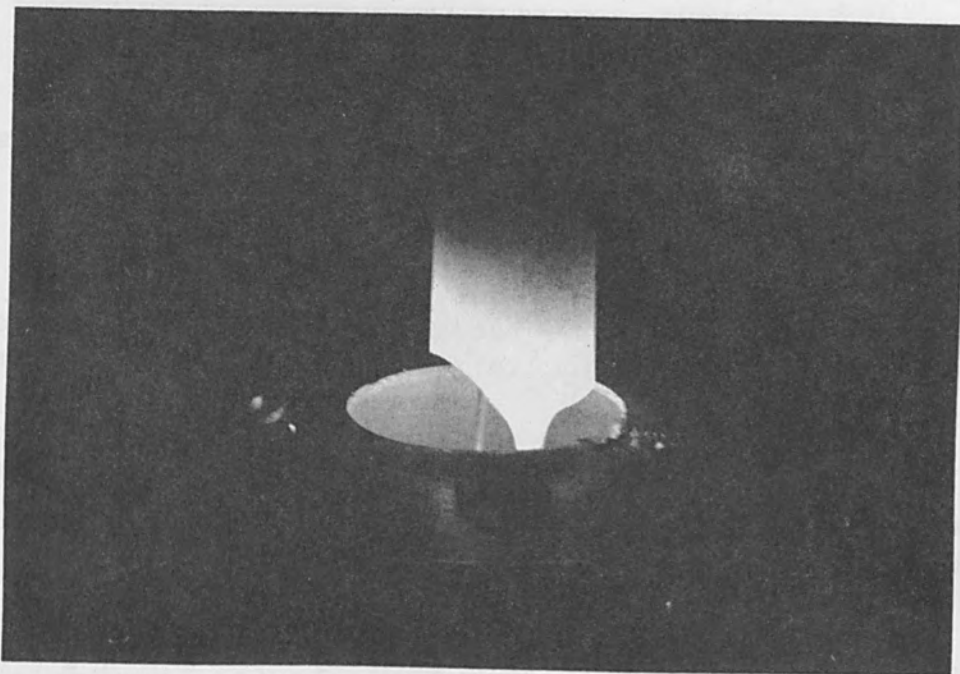

Figure 6
Droplet Falling From Titanium
Feed Rod Into Crucible

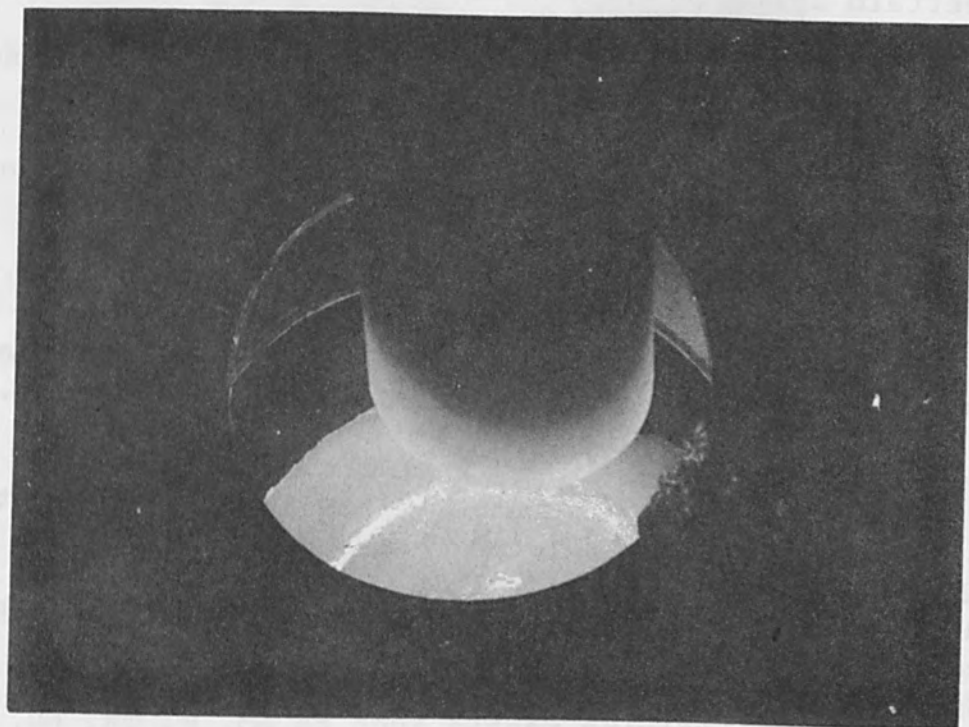

Figure 7
View of Molten Pool of
Titanium in Crucible

The macrostructure of this ingot after sectioning is shown in Figure 9. This material exhibits the normal grain structure observed in electron beam melted ingots, ie. extremely long columnar grains parallel to the direction of solidification. The remaining unmelted end of the titanium electrode is shown in Figure 10. The heat affected zone is revealed by the thermally etched region. The smooth regular shape of the electrode tip is indicative of the quiet melting observed with this particular titanium.

The economics and practicability of converting conventional arc melting furnaces to electron beam or the construction of a versatile unit for both electron beam and conventional arc melting is questionable since most existing arc furnaces would require rather drastic design changes to achieve a completely satisfactory electron beam melting unit. However, the work done with the current equipment has been very helpful in elucidating many of the problems associated with this relatively new melting technique and will be extremely useful in the design and construction of a unit solely for electron beam melting.

Large scale consumable electron beam melting has certain definite advantages with regard to melting reactive or refractory metals quite attractive for the consolidation of these metals without contamination, and for some metals ie. Nb, Ta etc., it offers the added advantage of appreciable purification. This includes both the removal of volatile metal impurities as well as gaseous impurities.

In conclusion the most important commercial applications of this process can be summarized as; up grading off grade lots of refractory metals by prime metal producers, the recovery of scrap in the form of powder, machine turnings or small reject parts etc. and the consolidation with associated purification of certain metals for special applications. When used in conjunction with a suitable feed mechanism the preparation of consumable electrodes can be avoided. The application of this form of melting in the field of alloy production must be investigated in more detail before definite conclusion can be reached regarding its usefulness. However, certain alloy systems, involving metals such as Mo, W, Ta, Nb, etc., lend themselves to this process.

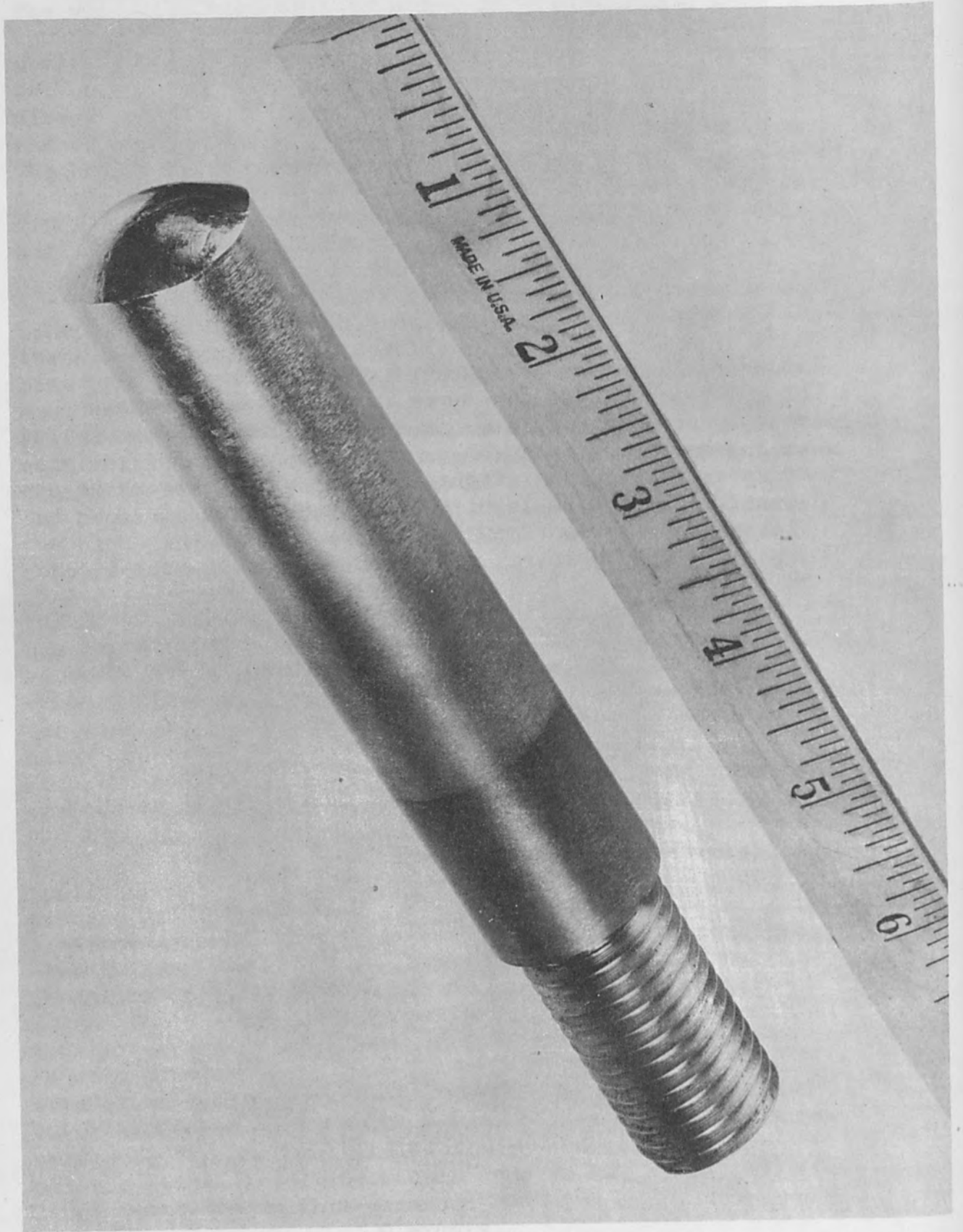

Figure 8
Titanium Ingot Melted by Electron
Bombardment (2" dia.)



Figure 9
Sectioned Titanium Ingot

Figure 10 Titanium Feed Rod Stub



THE ZONE MELTING OF TUNGSTEN BY
ELECTRON BOMBARDMENT

by

W. R. Witzke

National Aeronautics and Space Administration

As part of the NASA's general program of research on materials for use at very high temperatures, we have, at the Lewis Research Center, a substantial effort on the metallurgy of tungsten and tungsten alloys. Since it is generally believed that the brittle behavior of recrystallized tungsten is caused by small concentrations of impurity elements, a portion of this research is devoted to producing high purity tungsten and to determining if the elimination of impurities from tungsten significantly increases its ductility.

In order to reduce the impurity content in commercially available tungsten we have employed floating-zone melting using electron bombardment for heating. The important advantages of this method are a high temperature capability, a high vacuum condition, and a low power requirement.

The purpose of this paper is to describe the apparatus used for the zone melting of tungsten rods, to indicate some of the problems involved, and to discuss some of the results.

APPARATUS

A photograph of the electron bombardment zone melting unit is shown in Figure 1. The unit consists of a vacuum chamber containing the zone melting mechanism, assorted vacuum pumping equipment, and the electrical power and control equipment.

The vacuum chamber is approximately 24 inches high by 10 inches in diameter and is made of standard forged steel pipe. A water jacket surrounds the chamber.

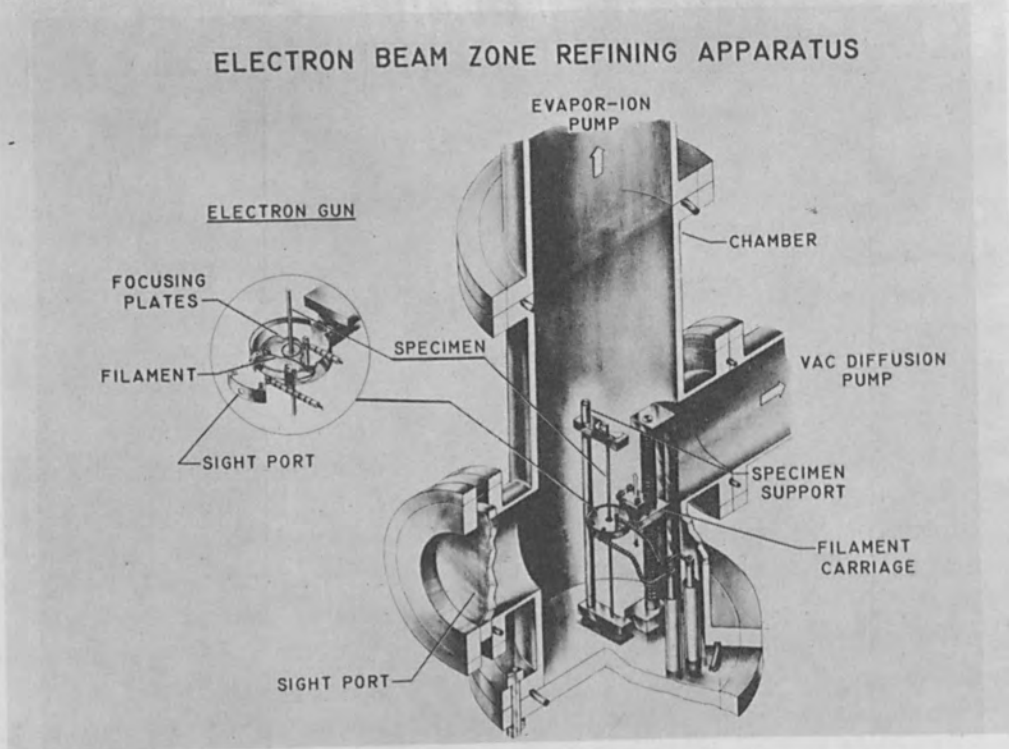

Figure 1

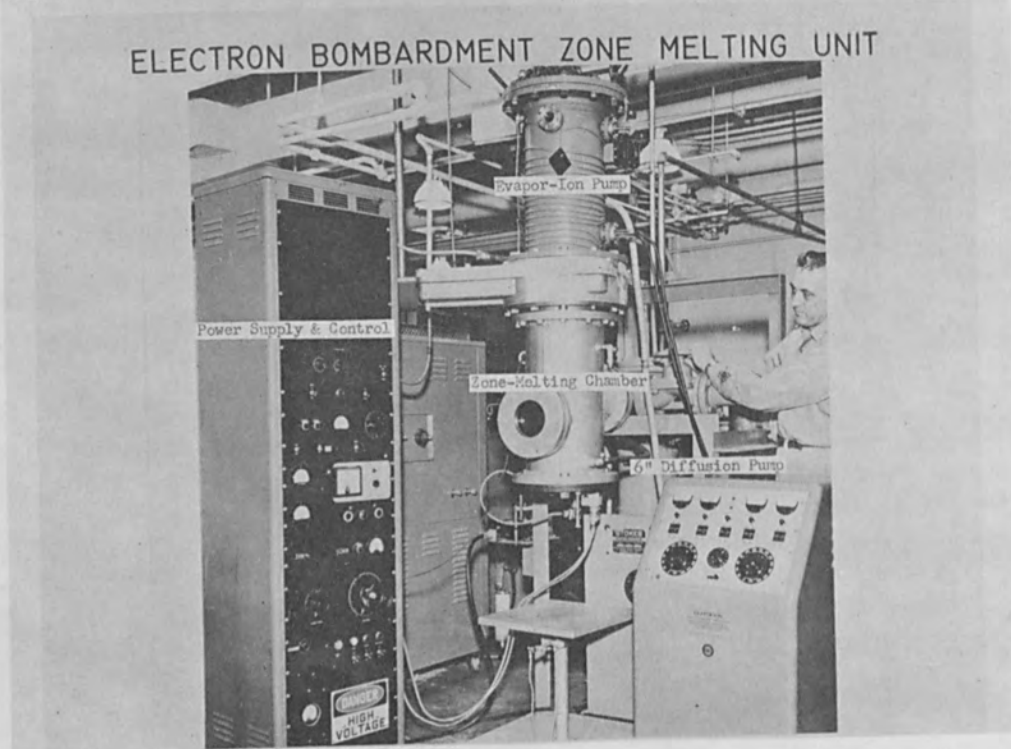

Figure 2

Several flanged openings sealed with O-ring gaskets are provided for a sight port and for vacuum connections.

The chamber is evacuated by an Evapor-ion (titanium-getter) pump and a six-inch diffusion pump package. A liquid nitrogen trap is used in conjunction with the oil diffusion pump to minimize backstreaming of oil into the melting chamber.

As can be seen in Figure 2, the zone-melting mechanism is attached to the base-plate of the vacuum chamber. This mechanism is made up of a number of small components: the specimen, the specimen support, the electron "gun", a lead screw and the gun carriage, and two electrical leads. The specimen remains stationary while the gun traverses up and down. The lead screw providing motion to the gun carriage is driven by a small D.C. motor through a gear reducer and a rotary vacuum seal. The copper electrical leads pass through and are insulated from the base plate by Mycalex insulators. In order to prevent a short circuit at this location due to coating of the insulators with evaporated tungsten, the insulators are shielded by Pyrex tubes.

The electron gun consists of a 0.020 inch diameter tungsten filament surrounded by several molybdenum focusing plates. The filament, made in the form of a loop about $3/4$ inch in diameter, is spaced approximately $1/4$ inch from the top and bottom focusing plates. The specimen passes through a $3/8$ inch opening in the center of the plates. An outer shield of molybdenum is included to aid in focusing the electrons. A small opening in this shield permits the operator to see the molten zone. Molybdenum screws hold the filament in place and also act as terminal posts for the flexible copper leads.

A functional block diagram illustrating the electrical circuit used for electron bombardment is shown in Figure 3. High voltage D.C. power is supplied by a transformer and two rectifier tubes. This supply of power is limited in voltage by a Variac and in current by a series of resistors. The high voltage is impressed on the filament, thus driving the electrons emitted by the

FUNCTIONAL BLOCK DIAGRAM OF ELECTRON BOMBARDMENT ZONE MELTING UNIT

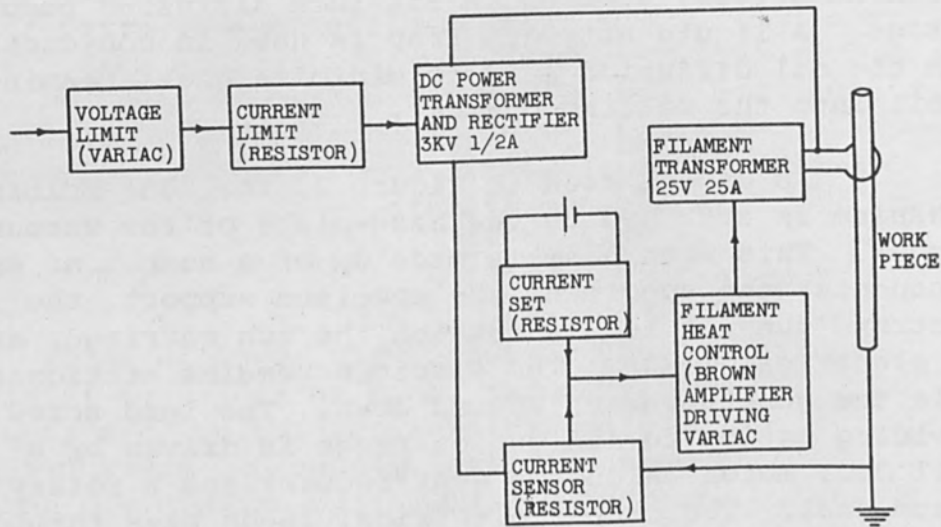

Figure 3

ELECTRON BOMBARDMENT FLOATING-ZONE MELTING OF TUNGSTEN

COMMERCIAL TUNGSTEN ROD



ZONE-MELTED TUNGSTEN ROD

Figure 4

heated filament to the grounded specimen. Current used in the electron bombardment is sensed by a resistor. The voltage drop across the resistor is compared to a control voltage determined by a variable resistor and battery circuit. The voltage difference or error is fed into the filament heat control, in this case, a Brown amplifier that drives the Variac feeding the filament transformer. The feedback, thereby, controls the electron emission and the bombardment current by varying the filament temperature.

OPERATION

The procedure normally followed in zone-melting a 1/8 inch diameter tungsten rod is to initially outgas the rod at a power level just below that required for producing surface melting. About 400 watts are presently used. With the gun traveling at about 10 mm/min at this power, the zone temperature is to about 5000°F. The melting pass that follows is usually carried out at a slower gun traverse rate, about 2.5 mm/min, in a downward direction and at a power level of about 600 watts. The power level is adjusted according to the appearance of the floating zone. If a bulge is seen in the bombarded zone, the core of the tungsten rod is considered to be completely molten. Subsequent metallographic examination of the zone-melted rods showed that the structure was uniform from the surface to the center, thus confirming that the rods had been completely melted. If too much power is applied, the surface tension forces become insufficient to support the molten zone and the rod "burns through".

The melting operation is usually carried out at a pressure of approximately 5×10^{-6} mm Hg. To avoid carbon contamination from backstreaming diffusion pump oil the Evapor-ion pump is used alone. The pressure can be further lowered to about 2×10^{-6} mm Hg during melting by using the additional pumping capacity of the six inch diffusion pump with its liquid nitrogen trap.

A number of difficulties have been experienced during melting. The most common problem is an overcurrent condition resulting from sudden gas bursts that can't be compensated for by the controller or the current limiter. An overcurrent relay breaks the circuit when

this condition occurs. The melting can usually be restarted without much noticeable difference in the uniformity of the specimen diameter.

In order to provide the maximum amount of zone-refined material for evaluation, we would like to produce zone-melted rods of uniform diameter. However, the bulge formed during melting carries away a small amount of tungsten from the starting region, leaving a necked section, and deposits this amount at the end of the pass. A rod having only these imperfections is shown in Figure 4.

About 50 per cent of the tungsten rods have a fairly uniform diameter after the first melting pass. The remainder have some defect. Often the rod will have a series of necked portions instead of the single initial necking that should take place. The cause of this rippled appearance is not known, but is believed to be related to such factors as the sharp temperature gradient existing in the heated zone and the vibration from pumps and other equipment. Further surface irregularity on the rod is attributed to control instability resulting from the outgassing of the rod and the deposition of vapors on the filament loop.

RESULTS

Up to this time, most of our effort has been devoted to developing the zone melting apparatus. We have, however, successfully zone melted both 1/8 and 3/16 inch diameter tungsten rods. An attempt was made to zone melt 1/4 inch tungsten rods but the power available was sufficient only for surface melting.

In order to achieve maximum purification of tungsten by zone refining, we would like to be able to make multiple melting passes. Although rods of relatively uniform diameter have been obtained after repeated melting, a defect on the rods in one pass may often be emphasized in the succeeding pass. Because of the desire to evaluate the zone melted material produced in this equipment, we have thus far concentrated on rods given only a single melting pass.

X-ray diffraction photographs of the edge of rotating specimens of 1/8 and 3/16 inch tungsten rods

ROOM TEMPERATURE BEND DUCTILITY OF TUNGSTEN

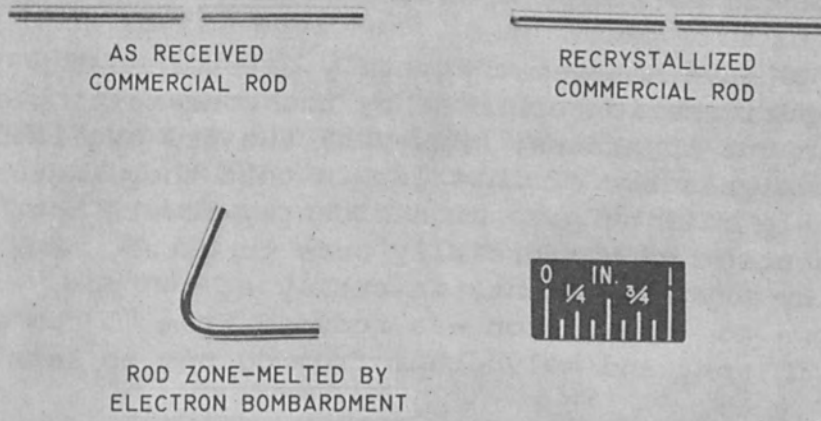

Figure 5

ZONE MELTED TUNGSTEN SINGLE CRYSTAL TENSILE TEST, 2500° F

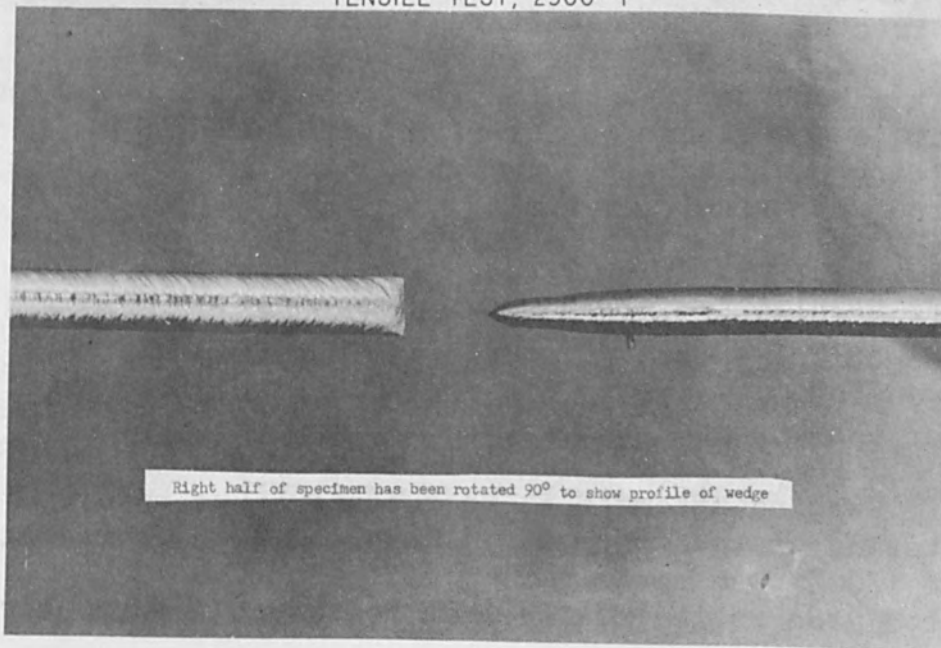

Figure 6

indicate that a single crystal is usually formed during the first zone-melting pass. Macroetching of zone-melted rods also indicate that they are single crystals. Certain crystallographic planes are selectively etched and extend the full length of the zone-melted section.

We have not yet adequately determined the extent of purification achieved by the zone-melting of tungsten in our apparatus. However, the few available chemical analyses are of interest in that they indicate that a single melting pass significantly lowers the impurity content of commercially pure tungsten. For example, the oxygen content, initially at 140 ppm, was brought down to 4 ppm, iron was reduced from 40 ppm to less than 10 ppm, and molybdenum from 80 ppm to less than 30 ppm.

In order to determine if zone-refining improves the ductility of tungsten, we have conducted room temperature bend tests. The results of some of the bend tests are illustrated in Figure 5. The "as received" (swaged and centerless ground) rod exhibited no bend ductility. Another piece of this rod, which had been recrystallized during an annealing pass in an attempt to degas it, was also brittle. In contrast, the one-pass zone-melted rod was quite ductile and bent through an angle of 110° without fracture. The test fixture which has a fulcrum with a $3/32$ inch radius limited the angle of bend to 110° . It is not known at this time whether the increased ductility is the result of purification achieved by zone-melting or is solely due to the fact that the zone-melted rod is a single crystal.

A few high temperature tensile tests of the zone-melted tungsten rods have been conducted. Figure 6 shows the chisel-shaped fracture of a specimen that was evaluated at 2500°F . Slip lines can be seen along the length of the specimen where deformation occurred.

Swaging attempts at room temperature resulted in shattering of the zone-melted material but swaging at 1600° to 1700°F was readily accomplished. The zone-melted rod also rolled easily when heated to about 900°F .

CONCLUDING REMARKS

The electron bombardment, zone-refining apparatus described in this paper has proved useful for preparing high purity tungsten single crystals. Modifications are being made to the equipment in an attempt to improve the surface uniformity of the zone-melted rods. We are currently attempting to determine the effect of multiple melting passes on the purification of tungsten, utilizing both chemical analyses and low temperature electrical resistivity measurements to establish impurity concentrations. In this way, we hope to establish a better correlation between tungsten purity and its mechanical properties.

AN ATTEMPT TO ZONE MELT SAPPHIRE BY E-B TECHNIQUES

by

A. R. Strnad

Bell Telephone Laboratories, Inc.

Murray Hill, New Jersey

In the interest of determining the feasibility of zone refining sapphire rods, an apparatus very similar to that used by A. Calverley was constructed. The main difference is found in the electron gun design. Calverley uses a simple gun arrangement consisting of a tungsten wire filament with beam forming plates and the metal sample itself acts as the anode. He reports the melting of an alumina rod but in order to start the operation he had to draw a conducting pencil line on the sample. In our gun design we have introduced an anode and this avoids the necessity for any special starting arrangement. Our gun design is shown in the accompanying Figure.

We began our tests by using a sample of 1/8 inch diameter centerless ground sapphire rods and initial results looked very promising. However, it was discovered that what we thought to be a molten zone was primarily a surface melt and that in order to produce and sustain a completely molten zone it was necessary to nearly double the beam power. For 1/8 inch diameter sapphire rod a beam power of approximately 90 watts is required for a "surface" melt and approximately 160 watts is required to melt through. The melt-through is determined by rotating the upper half of the sample with respect to the lower half.

Having achieved a molten zone we then proceeded to traverse the sample in an attempt to zone refine. As the zone refining procedure continued it became evident that the molten zone was "necking" and diminishing in size. It is apparent that the molten sapphire is evaporating since there is a considerable accumulation of deposited material on the cool anode. Eventually the filament exhibits an uneven temperature distribution along its circumference and the melting procedure has to be terminated.

We believe that the disparity between the power levels required for surface melting versus melt-through is the result of the transparency of the sample rod which allows excessive heat to be radiated along its longitudinal axis.

A zone melt was tried with a ruby rod of 1/8 inch diameter and it was interesting to note that in the region where the molten zone was sustained there was an absence of ruby color. Therefore it is fairly evident that the chromium was removed either by zone refining or possibly evaporation.

The electron gun was operated with 2,000 volts anode potential with the beam forming electrodes at cathode potential. The cathode current was approximately 80 milliamperes and the cathode temperature was 1930°C.

Although the zone refining of sapphire does not at present look very promising, we have demonstrated that it is possible to melt dielectric materials by the electron bombardment technique.

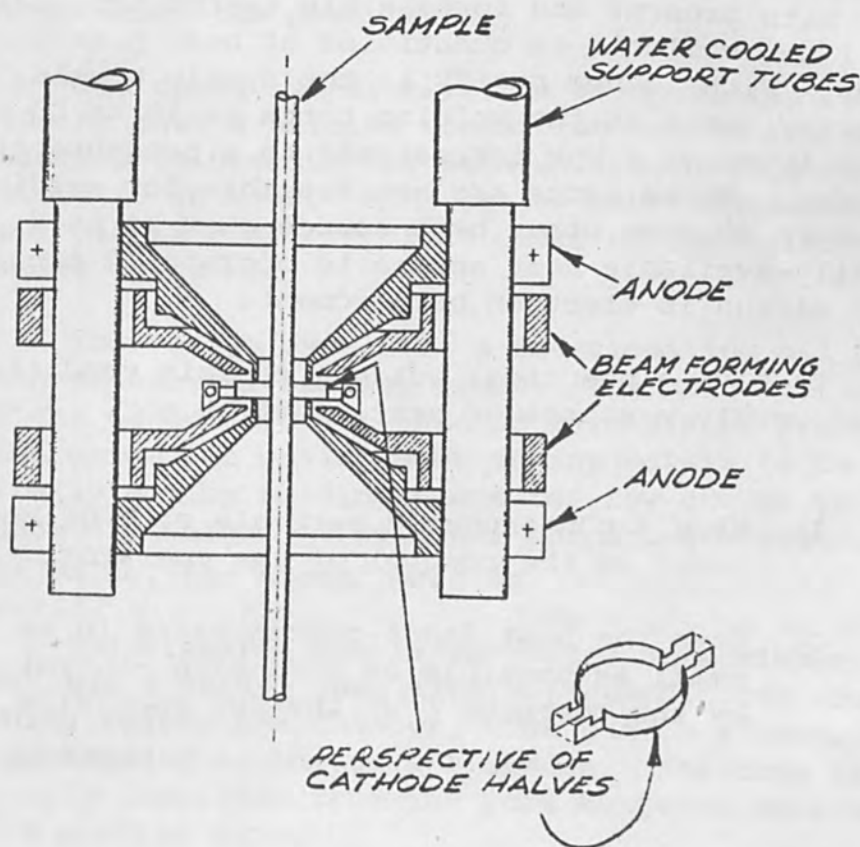

A COMMERCIAL ELECTRON BEAM WELDER
by
Theodore H. Crane
High Vacuum Equipment Corporation

Electron beam welding is the logical "next step" in welding processes. With the increase in the knowledge of the effect of impurities on the exotic metals and even the common alloys of commerce, greater and greater purities of weld deposit have been demanded. Very close correlation has been found between gas contamination and corrosion resistance in titanium and zirconium and their alloys. The role of inclusions in notch sensitivity for all welded structures has been evaluated to display the full effects of impurities down to even crystal dislocations. This all leads to a growing urgency to maintain cleanliness in metals through their history including the welding stages of fabrication.

With present and foreseeable technology, shielding gases will be available in quantities at best 5 to 10 ppm impurities. With 10 ppm purity in the supply bottle, the useful purity level at the welding torch is 10 to 20 ppm. The purity level of 1 ppm corresponds to a pressure of 0.76 microns. Normal arcs are not feasible for welding at this pressure so some other heat source must be used. The most readily-available heat source to operate at pressure below 0.7 micron is electron bombardment.

To have a practical welder, certain conditions, other than merely a source of heat, must be met. A welder should;

1. Have a continuously variable rate of heat input at the control of the operator.
2. Have the heat input concentrated in as small as possible an area with control by the operator over the hot spot size.

3. Have the work readily-visible during the entire welding cycle.
4. Be safe in normal operation for both the equipment and operators.
5. Be simple in design for ease in operation and maintenance.

Our electron beam welder was designed to approach the requirements for a commercial welder. The upper operating voltage of the small welder was selected as the upper safe limit for x-rays without extra shielding. The 15 kilovolt level is also easy to handle from a design standpoint with respect to overall compactness of the equipment.

The present equipment is the result of extensive tests on two previous generations of electron beam devices. The first one was able to only light phosphorus on a stainless steel plate. After much work we reached a point where one of our people burned his finger on the target. A second generation machine using the same power supply was blasting holes in moly and tungsten a few days later. While the production prototype was being built, a bell jar was used to further study the power supply.

The operation of electron beam welding is simple to the point that a skilled technician can be trained in a few minutes to operate the machine. An office worker was trained in an hour. With two or three days training any plant can have an efficient cadre of good electron beam welder operators.

The vacuum system is a fractionating oil diffusion pump with mechanical backing pumps. The principal requirement of the vacuum system, that of maintaining pressures below the oxidation environment of any metals to be welded, is generally met by holding pressures low enough to prevent local glow discharges. The usual operating pressures are 5×10^{-5} mm Hg. for normal welding.

The electron gun is supported on a simple sliding shaft through a vacuum seal with adjustments for rough positioning inside the chamber. The gun is a cone, the vertex perforated as the grid aperture. The cone is electrically insulated from the pure tungsten emitter and acts as a control grid.

In operation the gun is located about two inches from the work and the cathode brought up to about 75 per cent of the welding current emission temperature. The work rotation mechanism is started and high voltage turned up to welding voltage. This cleans the work surface. One pass at the desired seam under these conditions is enough from our experience to date. With clean, freshly-machined parts this bombardment cleaning is not required.

When the welding current is increased by raising the filament temperature, a bright red spot develops instantly on the work; in seconds a molten pool is formed. This pool is apparently two to five times the true electron spot diameter. The operator may control the size of the pool by welding voltage, by filament temperature, or by welding travel speed. In normal welding the voltage and filament temperature are fixed by experience on the particular metals to be welded. Control of the width of the fusion zone and penetration is determined by the travel speed. To finish the weld neatly, the travel speed is advanced to maximum and the voltage is turned down to extinguish the hot spot.

The use of the beam welder for production of finished parts is governed by the same general rules as the conventional dry-box welding technique. That is to say the parts should be designed and fixtured so that rotation is in a single plane per weld. It is best that the edges to be welded are jogged or upset so that no additional filler metal is required. In many instances the fused zone is not objectionable with a slight depression. If this is the case, this removes the requirement for any special edge treatment.

Production of ductile tungsten-to-tantalum welds has been done on this type of machine. In this case sintered tantalum bodies were welded to tungsten lead wires. The bodies were about $\frac{3}{16}$ inch square by $\frac{5}{8}$ inch long and were welded to .020 inch tungsten wire. The test of the weld was to take the tungsten leads and bend them to a right angle at weld. There was no visible distortion of the square body.

A particular application is the welding of thermocouple junctions. The beam technique is ideal in that a small junction is rapidly made without time for

undesirable side effects such as diffusion of the junction or the introduction of impurities at the junction. The needle sharp hot zone makes the focused beam useful for even the finest wires.

The use of the electron beam welder for production of Dewars affords a combined pump-out and assembly technique. The small heat-affected zone also permits gold or other plating to be used to restrict infra-red radiation heat transfer between the walls of a flask.

Electron tube parts welded by electron beam welding are cleaner, with no oxide content introduced in fabrication. The weld zone is fully degassed instead of gas saturated. Copper and copper based alloys can be easily welded without preheat and without oxidation. Even clean copper is brighter after electron beam welding.

Another application for the electron beam technique is the fabrication of nuclear fuel elements. Zirconium, aluminum, or stainless steel cladding can be readily and safely canned by the welder. The beam welder technique is very good where there is a requirement for rolling or extrusion after cladding as there is no requirement for separate evacuation. The high consistent quality of the welds reduces the chances of spillage of the active material.

From the metallurgical evidence available it would appear that electron beam welding is the only feasible way to weld beryllium. The absolute freedom from oxidation should contribute to the safety of beryllium fabrication. Since a satisfactory weld can be made, much drilling and tapping with attendant oxide formation is eliminated.

The beam at 15 kilovolts will melt ceramics almost as rapidly as metals. There is some darkening of the ceramic to indicate reduction by a combination of ionization and the low ambient pressures. No investigation has been made to date but it appears that this technique is applicable to production of ceramic-to-metal seals.

Skull melting of ceramics has been done using the welding head with a great deal of success. This procedure is a little difficult as the grains of the non-metallics ionize and are apt to be attracted to the grid.

This same phenomenon is present in welding such metals as aluminum and common open hearth steels. These metals are generally higher in oxide type inclusions. The inclusions are ionized in the fusion zone and literally lifted out of the melt. During the melting operation bright motes are seen to fly out of the melt and to the grid. After a series of runs the nose of the cone is seen to be coated with unknown particles. The electrical resistance of this coating is very high, leading us to the conclusion that these coatings represent refractory oxides. From micro-photos it would appear that non-metallic inclusions are removed from the fused zone.

Electron beam welding is so new that a detailed discussion of the usefulness of the technique and the limits of its applications would be impossible. Most of you in attendance here have applications, requirements, and demands for the use of this technique that we haven't seen yet. A heat source with an upper temperature limit above tantalum carbide's boiling point, but with control to weld .0005 inch zirconium foil, is bound to have a large number of applications in many different fields:

As production orders for electron-beam welders are being processed, further plans are being rapidly developed. Already the beam technique appears to be the answer for continuous annealing of strip metals and as a source of continuous metallizing with almost any metal onto any substrate. Crystal growing and zone refining are a "natural" for the focused beam technique. Like any new welding process, we can see today only a tiny part of the potential of the machine.

ON THE PURIFICATION OF TUNGSTEN BY ELECTRON

BEAM REFINING

by

J. W. Pugh

General Electric Company

The work which I will describe has been done in the General Electric Company's Refractory Metals Laboratory which is part of the Lamp Metals and Components Department in Cleveland. It was started by R. G. Carlson⁽¹⁾ and is being continued by L. H. Amra. Our objective is to examine the properties of purified materials rather than to develop an electron beam device. Currently, we are most interested in tungsten, but we have made single crystals of zone melted molybdenum, tantalum, and platinum.

Figure 1 is an electrical diagram of our circuit which makes available 5000 volts and 0.3 amp. Control is obtained by means of a variac which limits a 110 volt AC source fed to a high voltage transformer. The high voltage power is rectified by a pair of half wave mercury rectifier tubes and then fed to the anode. The cathode is the ground terminal.

Figure 2 is a schematic drawing of the apparatus showing a sample surrounded by a moving cathode and concentrator assembly. The most satisfactory traversal rate for tungsten appears to be about 0.5 cm per minute. Single crystals of tungsten which are 4 inches long x 0.120 inches in diameter are made in this way. Such crystals are sufficiently ductile that they can be readily bent and twisted at room temperature. A photograph of a bent crystal is shown in Figure 3. The shiny bent section is the purified crystal. At each end of the crystal are untreated sections of the starting rod.

More satisfactory evidence of ductility is provided in the tensile curves of Figure 4. These tests were made at room temperature using the strain rate 0.02 inches min^{-1} . Specimens had a 1 inch gage length and an .080 inch

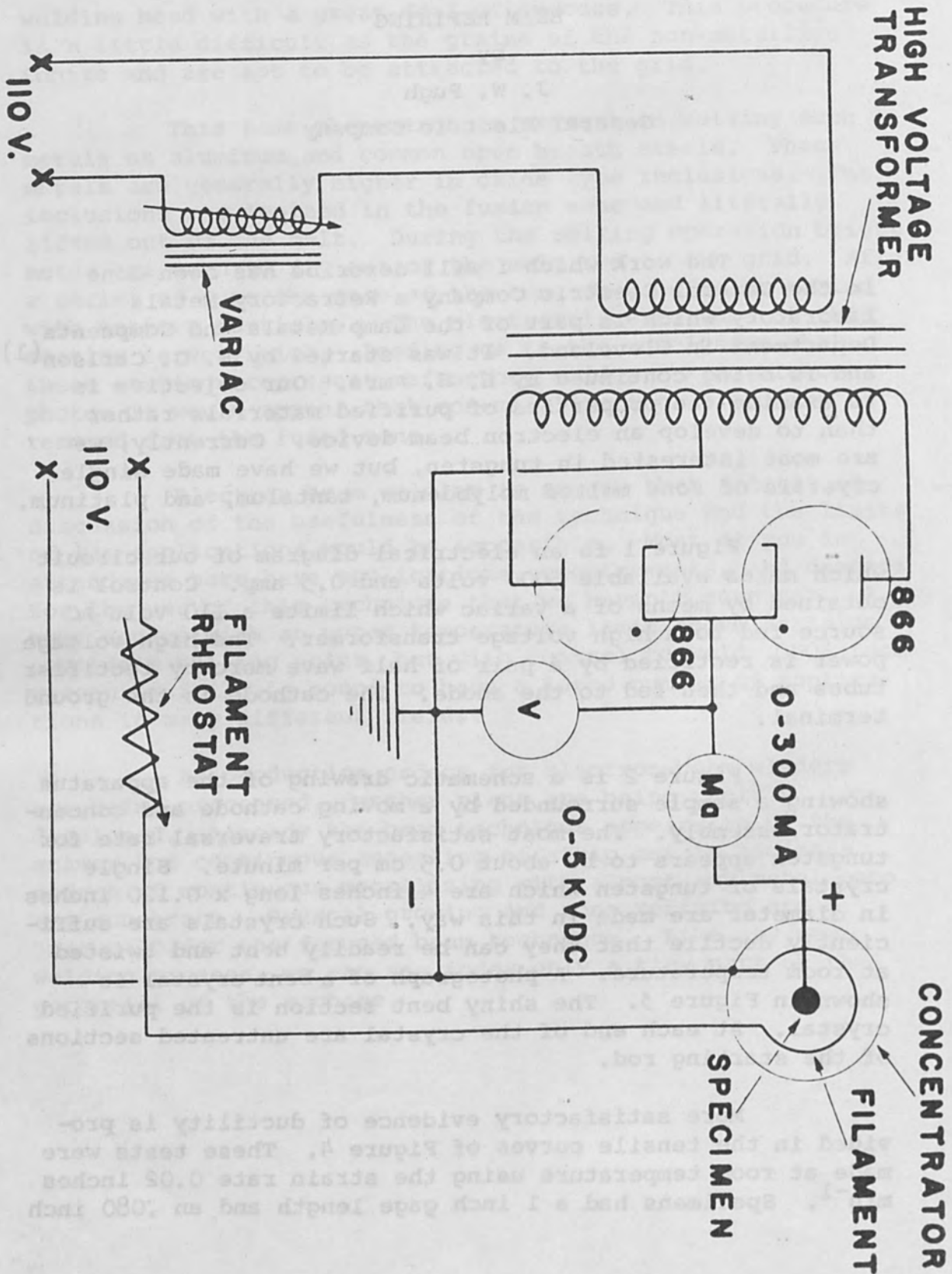

Figure 1 Wiring Diagram of the Power Source

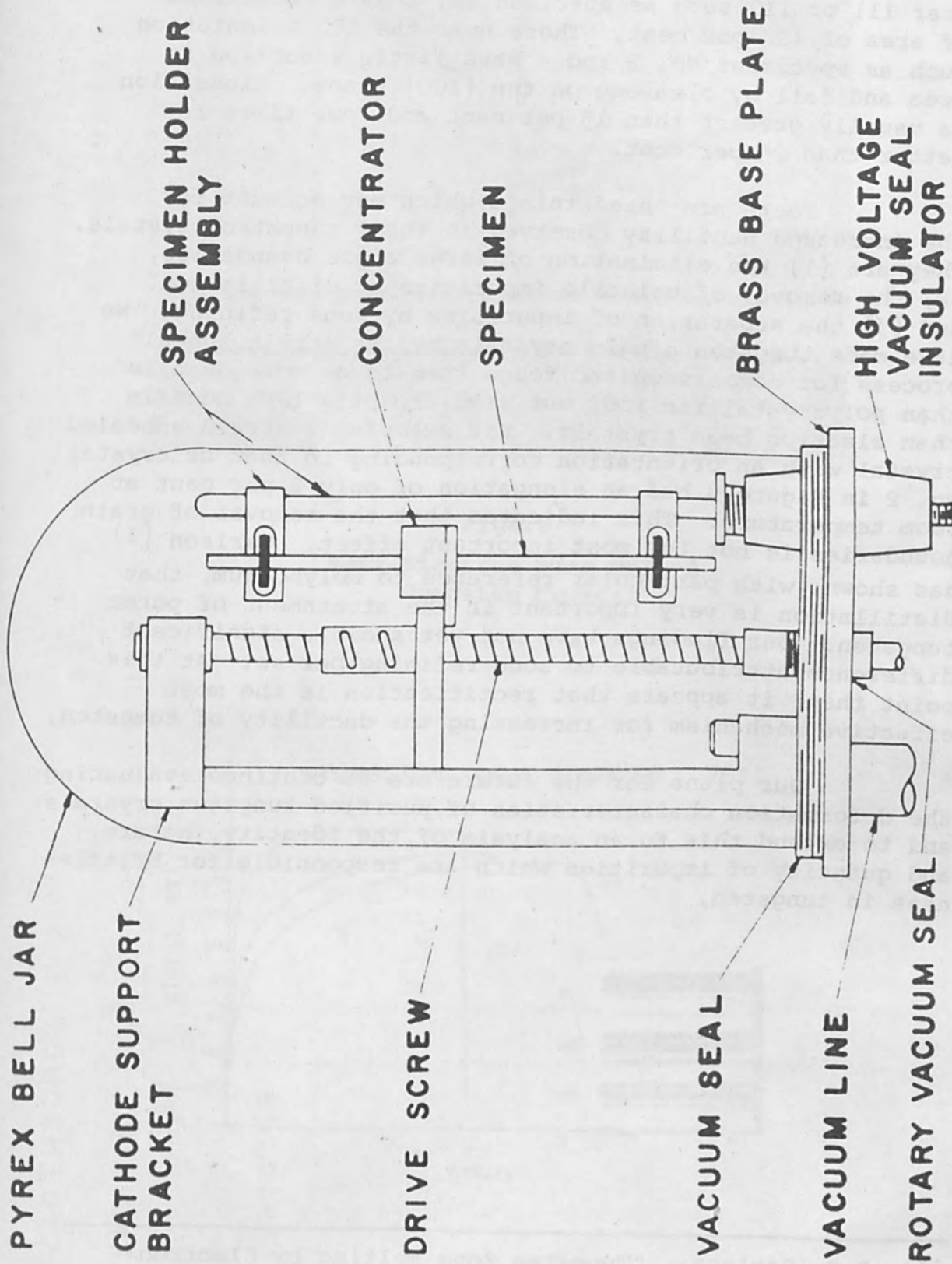

Figure 2 Schematic Drawing of the Electron Beam Traversing Mechanism

diameter test section. Crystals whose orientation is near 111 or 110 such as specimen No. 1 have reductions of area of 100 per cent. Those near the 100 orientation such as specimens No. 2 and 3 have little reduction in area and fail by cleavage on the (100) plane. Elongation is usually greater than 15 per cent and some times is better than 25 per cent.

There are three things which may account for the increased ductility observed in these tungsten crystals. They are (1) the elimination of large angle boundaries, (2) the removal of volatile impurities by distillation, and (3) the separation of impurities by zone refining. We have made tungsten single crystals by the strain anneal process for comparison and found them to be more ductile than polycrystalline rod, but significantly less ductile than electron beam crystals. For example, a strain annealed crystal with an orientation corresponding to that of crystal No. 2 in Figure 4 had an elongation of only 2 per cent at room temperature. This indicates that the removal of grain boundaries is not the most important effect. Carlson (1) has shown, with particular reference to molybdenum, that distillation is very important in the attainment of purer tungsten. Our findings have not yet shown a significant difference attributable to zone refining per se. At this point then, it appears that rectification is the most effective mechanism for increasing the ductility of tungsten.

Our plans for the future are to continue evaluating the deformation characteristics of purified tungsten crystals and to extend this to an analysis of the identity, nature, and quantity of impurities which are responsible for brittleness in tungsten.

(1) R.G. Carlson; "Tungsten Zone Melting by Electron Bombardment", J. Electrochemical Soc., V. 106, No. 1, Jan. 1959, p 49.

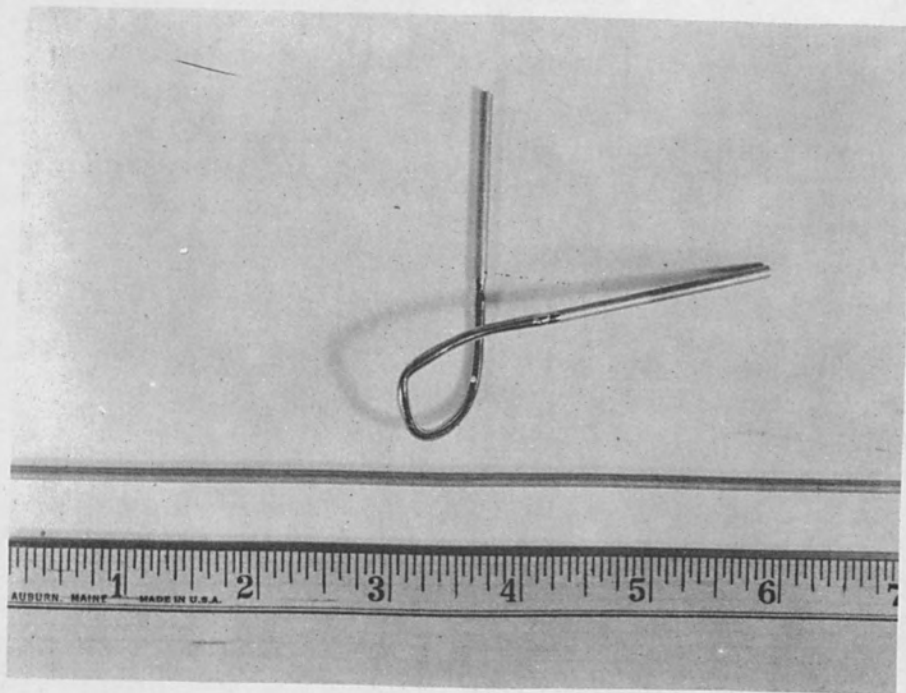

Figure 3
Bent Electron Beam Melted
Tungsten Crystal

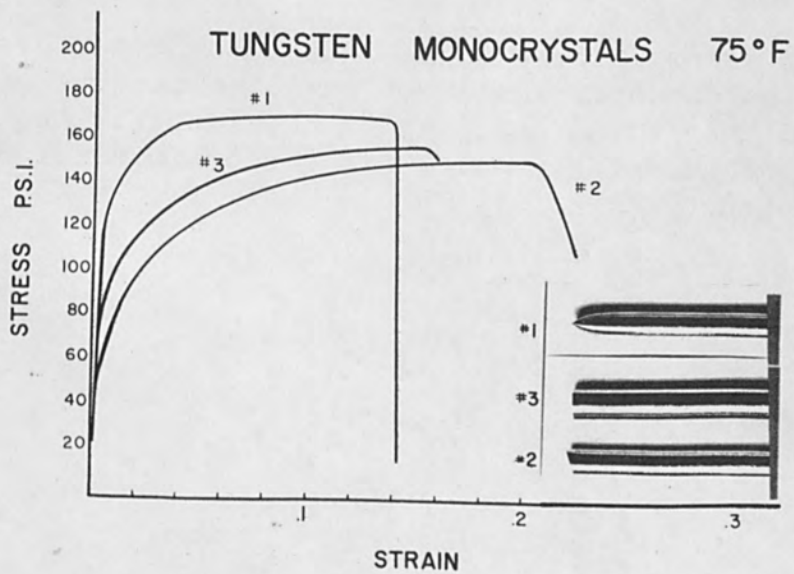
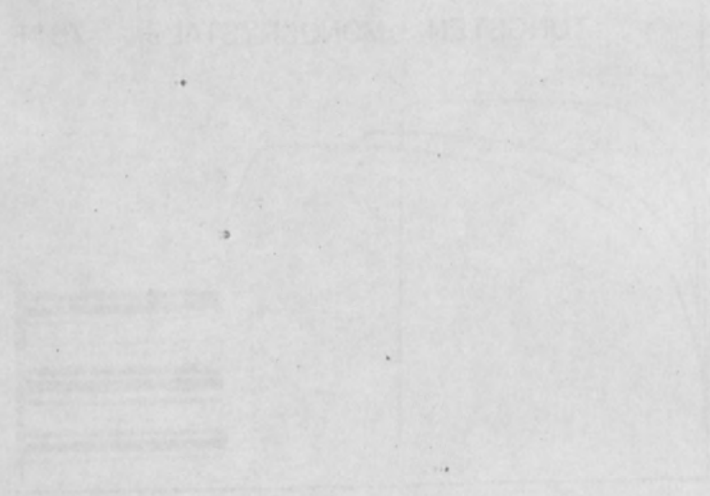
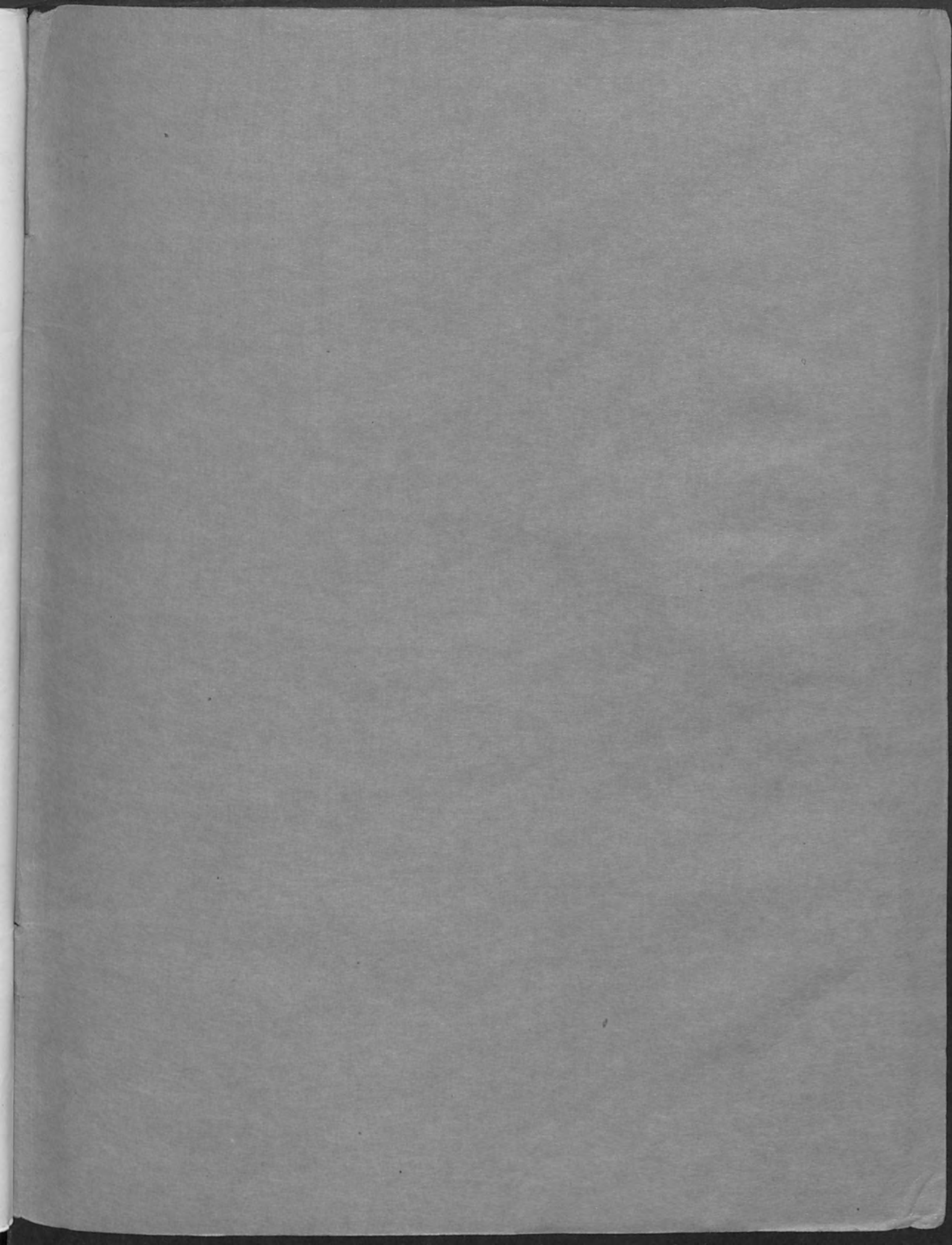

Figure 4
Tensile Curves For Electron
Beam Melted Tungsten Crystals







alloyd research corporation

WATERTOWN MASSACHUSETTS